

# PROTECTA® EX MORTAR

## INSTALLATION INSTRUCTIONS



### INDEX FOR DETAILED DRAWINGS

Linear seals in floors.....	page 2
Cables, cable trays and conduits in floors.....	pages 2-4
Steel pipes in floors.....	pages 4-7
Copper pipes in floors.....	pages 7-9
Alupex pipes in floors.....	pages 9-11
Plastic pipes in floors.....	pages 11-13
Composite pipes in floors.....	pages 13-15
Insulated plastic pipes in floors.....	pages 15-16
PEX pipes in floors.....	pages 16-17
Cables, cable trays and conduits in rigid walls.....	pages 17-18
Steel pipes in rigid walls.....	pages 18-19
Copper pipes in rigid walls.....	pages 19-20
Alupex pipes in rigid walls.....	page 20
Plastic pipes in rigid walls.....	page 20
Cables, cable trays and conduits in flexible or rigid walls.....	page 21
Steel pipes in flexible or rigid walls.....	pages 21-22
Copper pipes in flexible or rigid walls.....	page 22
Alupex pipes in flexible or rigid walls.....	pages 22-23
Plastic pipes in flexible or rigid walls.....	page 23

Please refer to Protecta® FR Damper for guidance on fire sealing ventilation ducts.

### GENERAL PRODUCT DESCRIPTION

Protecta® EX Mortar is a dry white powder consisting of inorganic compounds and perlite. When mixed with water the compounds form a highly thermally insulating fire seal to prevent the spread of fire and smoke through openings in fire rated walls and floors, including openings formed to accommodate building service penetrations. Protecta® EX Mortar expands by up to 1% by hydraulic action during curing ensuring a very tight seal around service penetrations and the surrounding construction.

### GENERAL GUIDE

**Minimum separations and limitations:** Services can be sealed as specified in the detailed drawings. An aperture can include several services, and they may also be different. The minimum permitted separation between adjacent seals/apertures is 200mm. Services should be a minimum of 30mm from seal edges. Services within the system Protecta® EX Mortar seal do not require a minimum separation, except pipes where combustible pipe insulation penetrates the seal and plastic pipe penetrations, which should be a minimum of 30mm from other services in the aperture. The total amount of cross sections of services (including insulation) should not exceed 60% of the penetration area.

**Supporting constructions:** Flexible walls must have a minimum thickness of 100 mm and comprise steel studs or timber studs\*) lined on both faces with minimum 2 layers of 12.5 mm thick boards. Rigid walls must have a minimum thickness of 100 mm and comprise concrete, aerated concrete or masonry, with a minimum density of 650 kg/m<sup>3</sup>. Rigid floors must have a minimum thickness of 100 mm and comprise aerated concrete or concrete with a minimum density of 650 kg/m<sup>3</sup>. The supporting construction must be classified in accordance with EN 13501-2 for the required fire resistance period.

\*) Timber studs: no part of the penetration seal may be closer than 100 mm to a stud, and minimum 100 mm of insulation of class A1 or A2 according to EN 13501-1 must be provided within the cavity between the penetration seal and the stud.

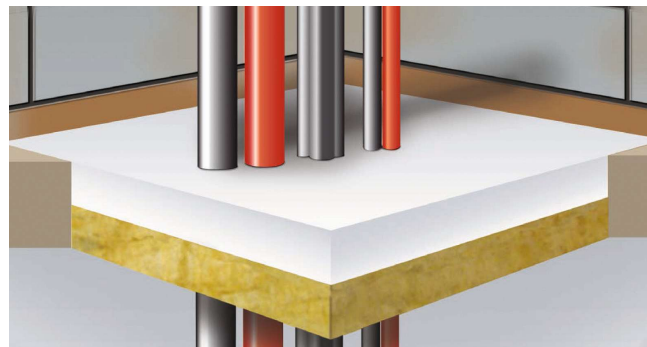

### INSTALLATION

1. When sealing drywalls the mortar should be flush with the surface of the wall on both sides.
2. When sealing masonry or concrete constructions, the seal can be positioned to either side of the construction or anywhere in between.
3. When sealing hollow floor slabs or boards, the seal should be level with the soffit side. There must be sufficient thickness of concrete below the void for the depth of mortar. Where this is not the case, tubular voids should be plugged, with for instance a PU foam, and the whole thickness of the floor should be cast with the mortar.
4. Any bare metal in contact with the mortar must be protected against corrosion using a suitable primer/protection system.
5. Ensure the faces of the aperture opening are free of dust and any other contaminants. The faces may be moistened for better adhesion.
6. If the mortar seal is required to be load bearing, please see instructions in the Technical Data Sheet.
7. Install a stone wool shutter board where it is necessary to achieve the required thickness of mortar (see the drawings on pages 2-23). Make sure that this achieves a very tight seal – any small openings should be sealed with Protecta® FR Acrylic. If a stone wool shutter board is described in the detailed drawings but another shutter is to be used, the mortar can replace the stone wool shutter if the total seal depth is the same or greater. Where a stone wool shutter board is not described, it is optional to use one and it does not need to be removed.
8. Pour clean water into a suitable mixing vessel and add the mortar to obtain the required consistency. Mix steadily at low speed and ensure that any lumps of powder are fully dispersed. Always add the mortar to the water, do not reverse this mixing process. For different mix ratios and drying times, please refer to the Technical Data Sheet.
9. Once the desired consistency is achieved pour or trowel the mortar onto the shutter board making sure that it flows into all corners and around services. Apply a firm pressure to the mortar to eliminate any trapped air bubbles. Build up to the required depth.

### STANDARDS

This Technical Data Sheet and the Installation Instructions are based on the product's European Technical Assessment issued in accordance with regulation (EU) No 305/2011 on the basis of EAD 350454-00-1104, September 2017, tested to EN 1366-3, -4 & -12 in conjunction with EN 1363-1. The product holds the following approval marks; CE-mark for Europe, UL-EU Certificate Internationally, UAE Certificate of Compliance & AS assessment for Australia and New Zealand.

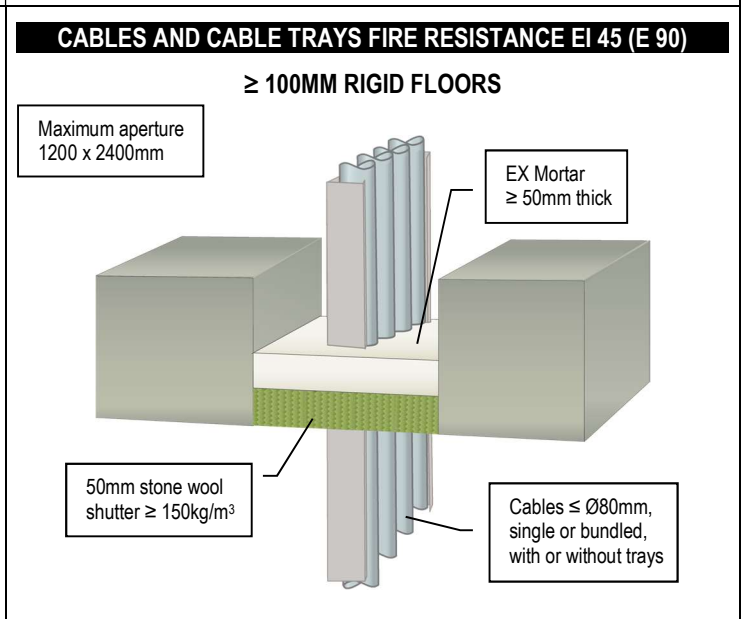
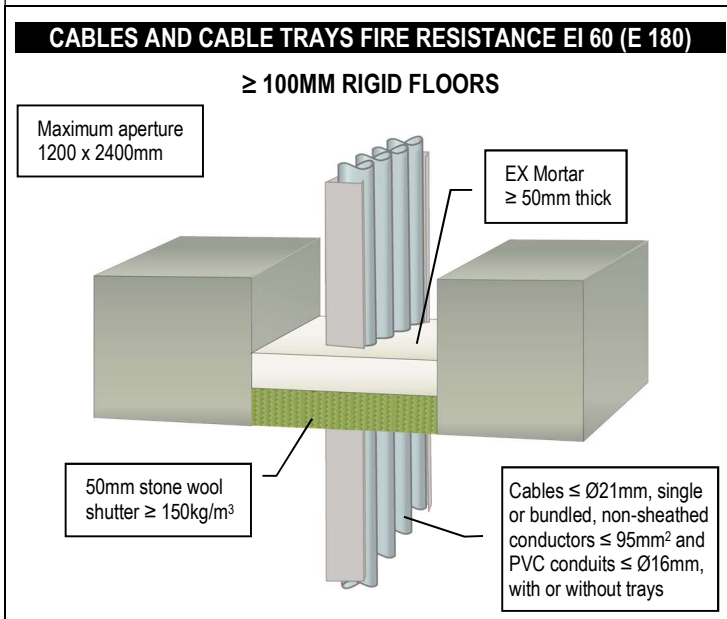
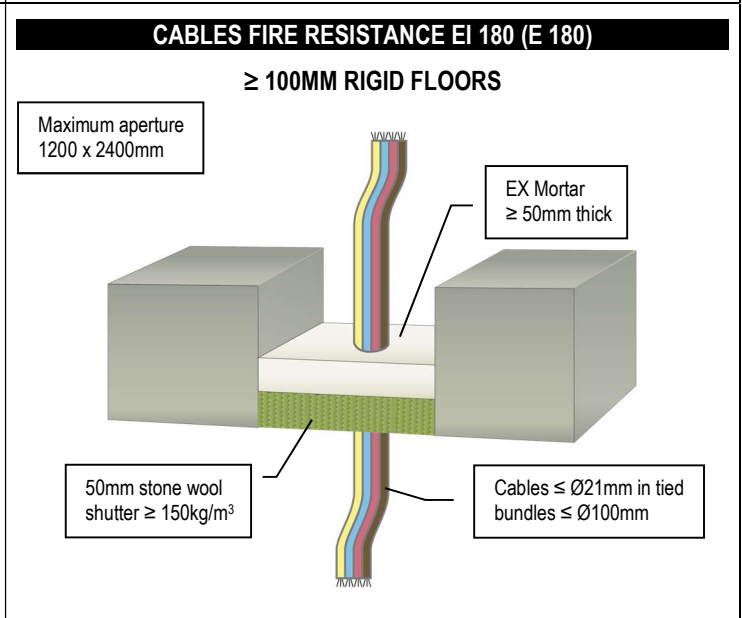
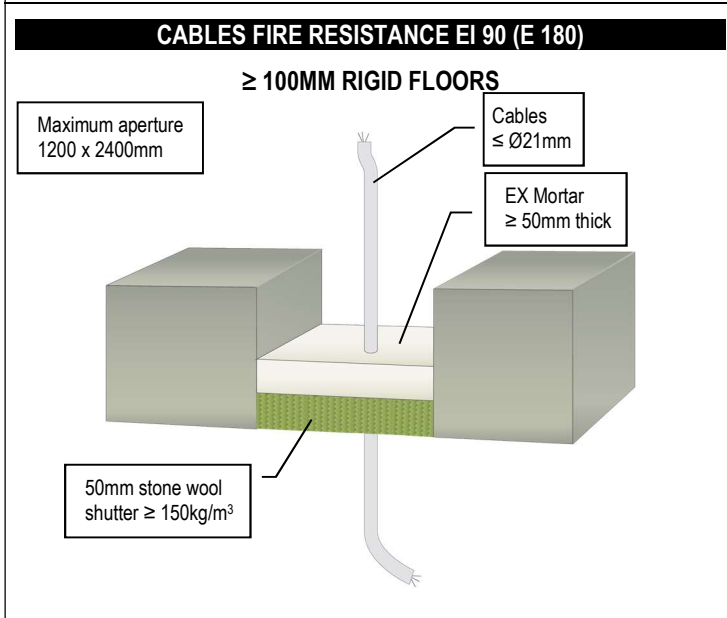
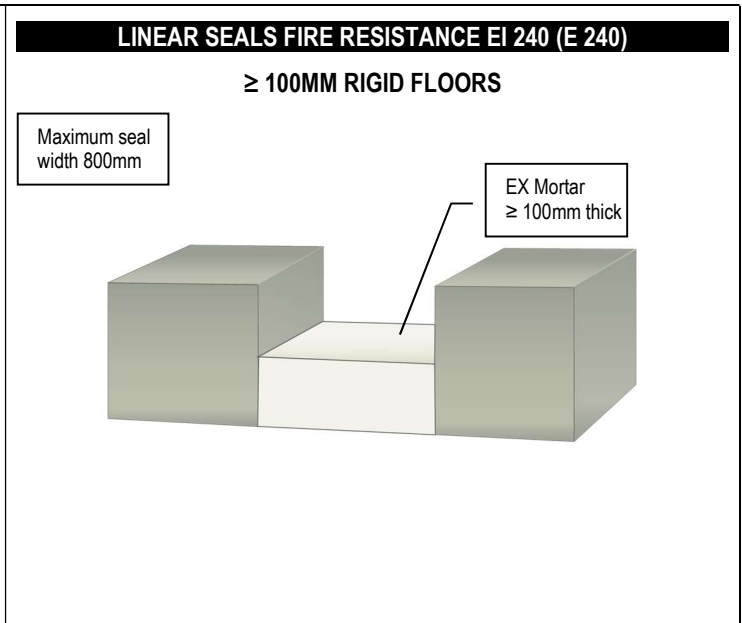
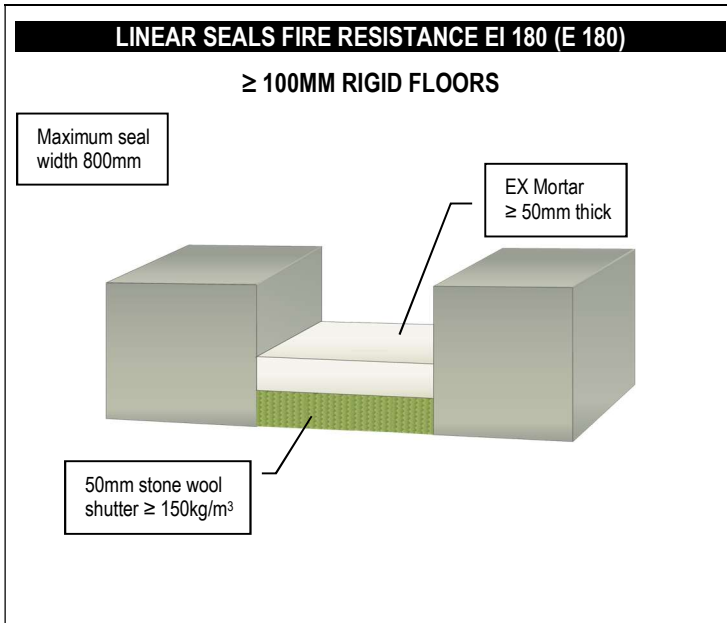

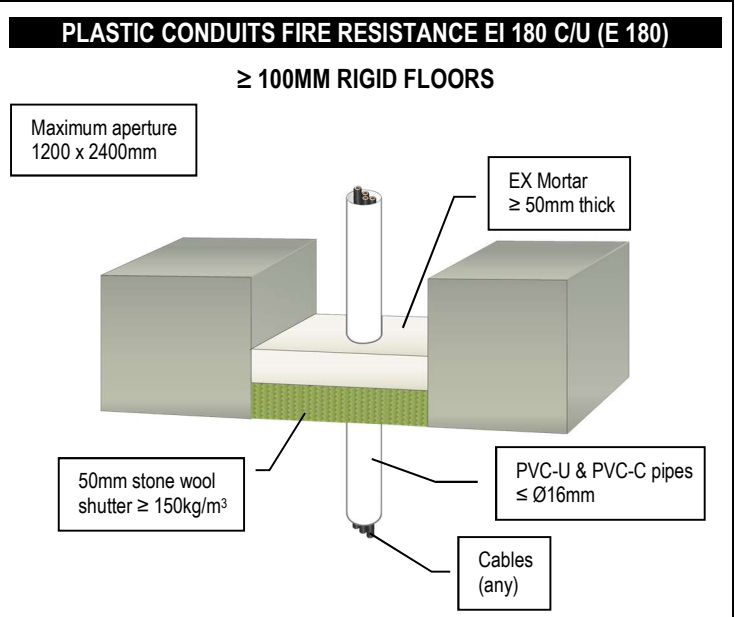
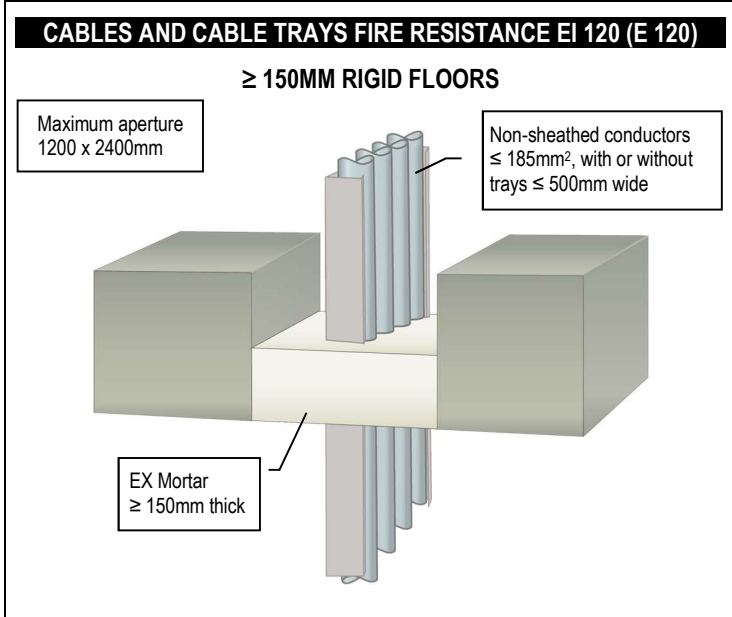
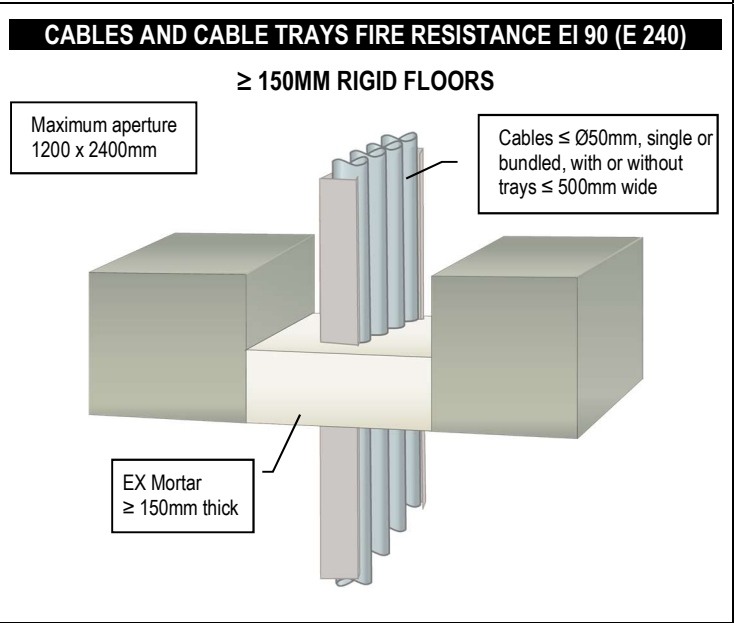
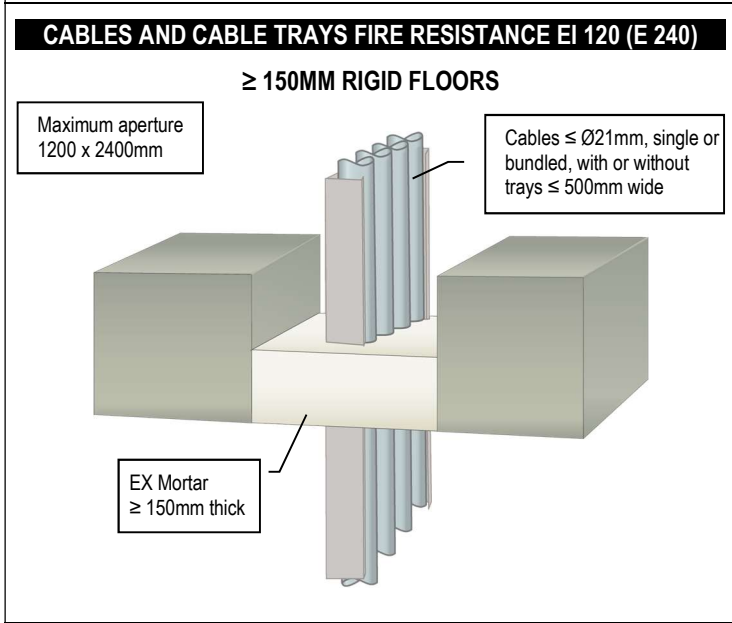
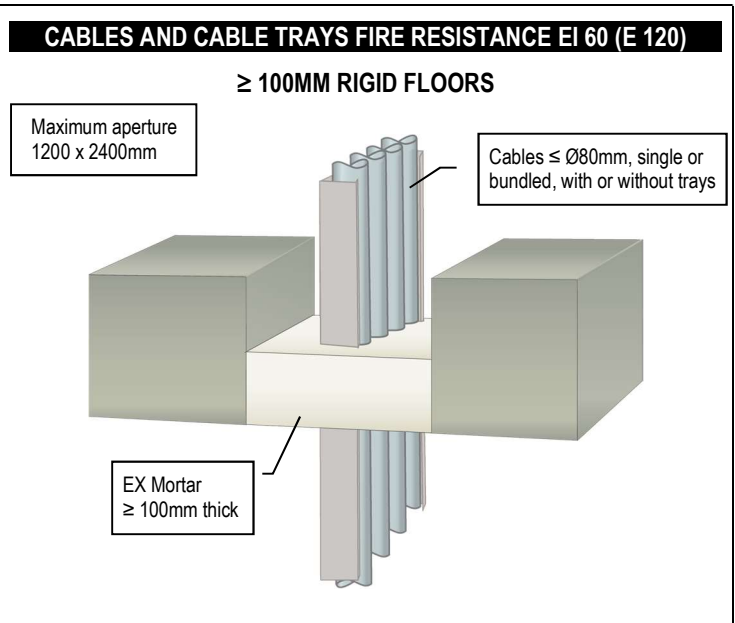
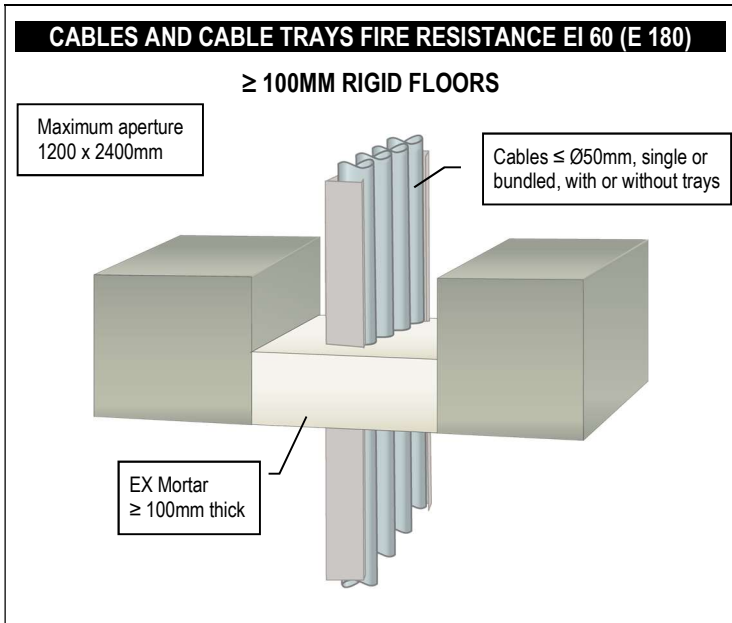

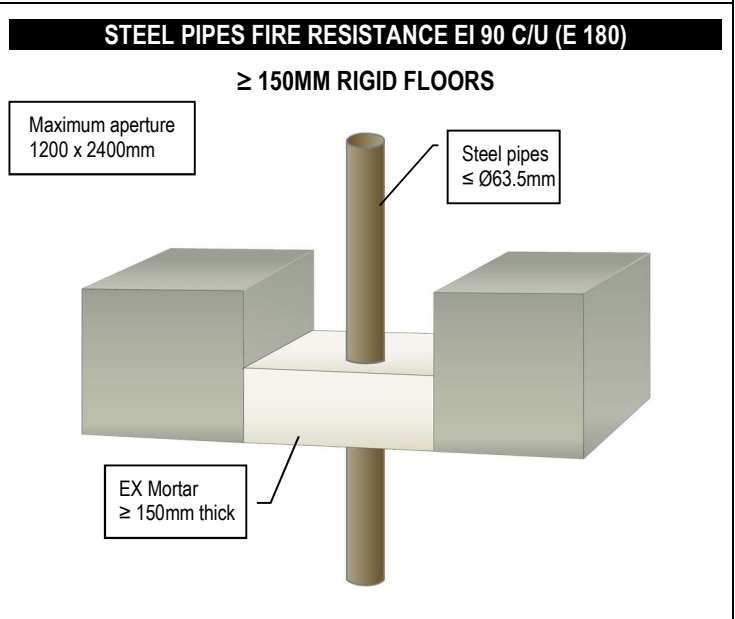
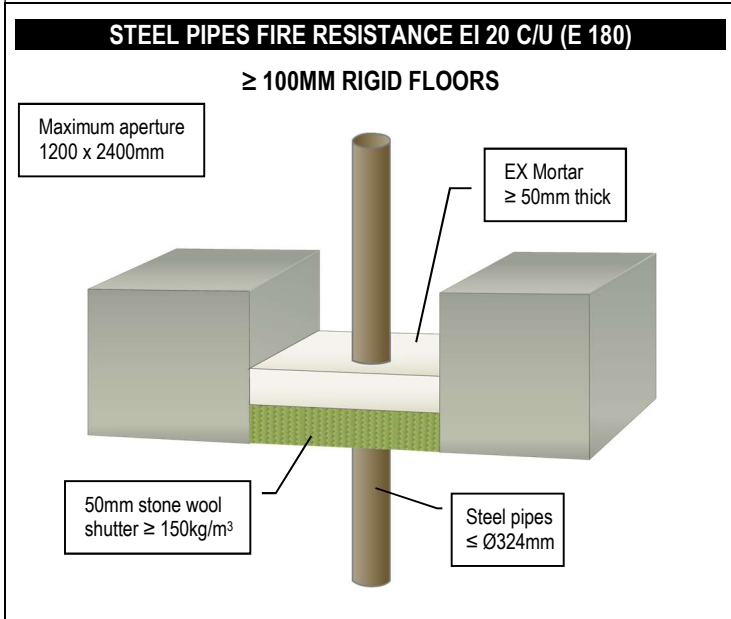
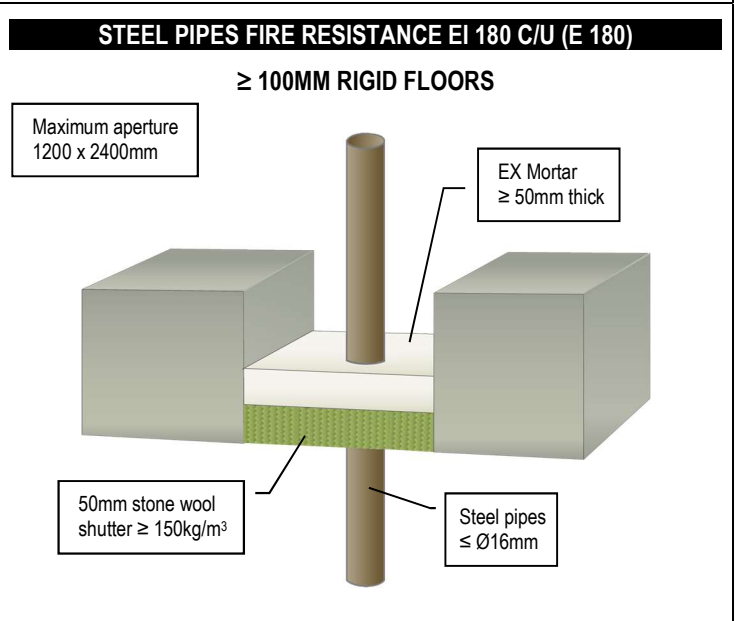
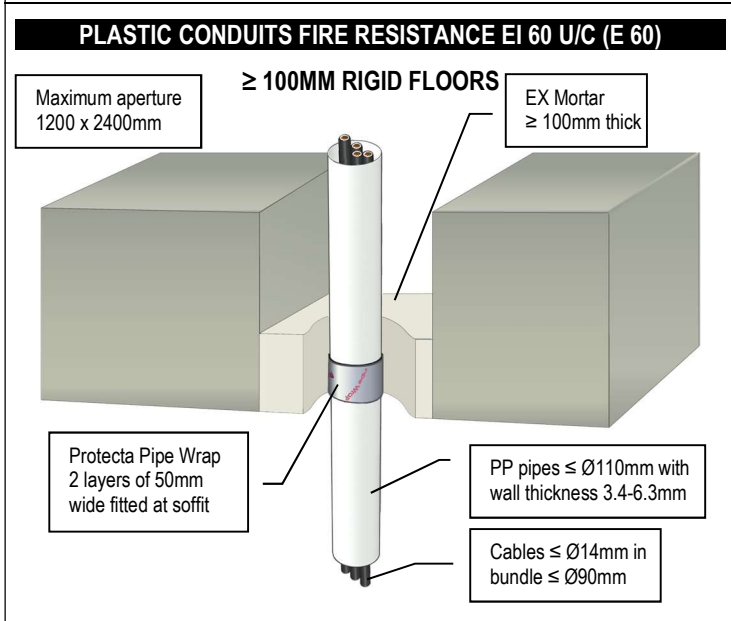
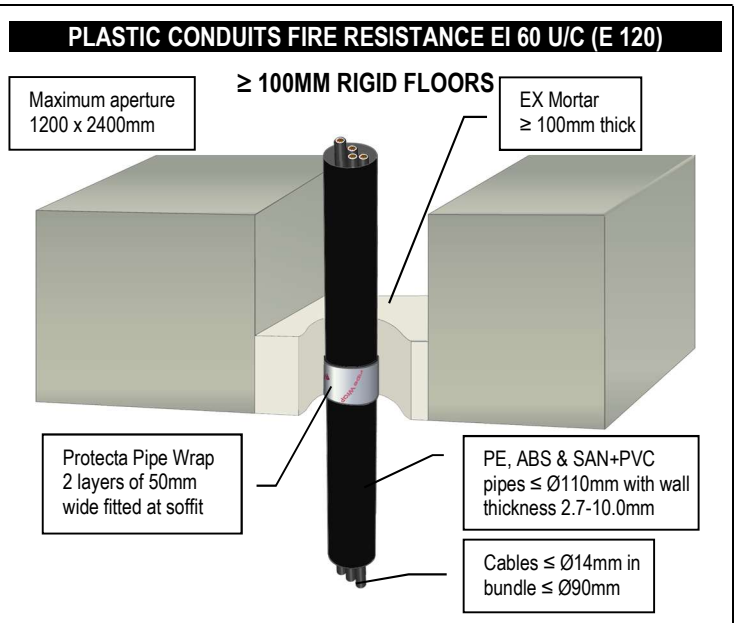
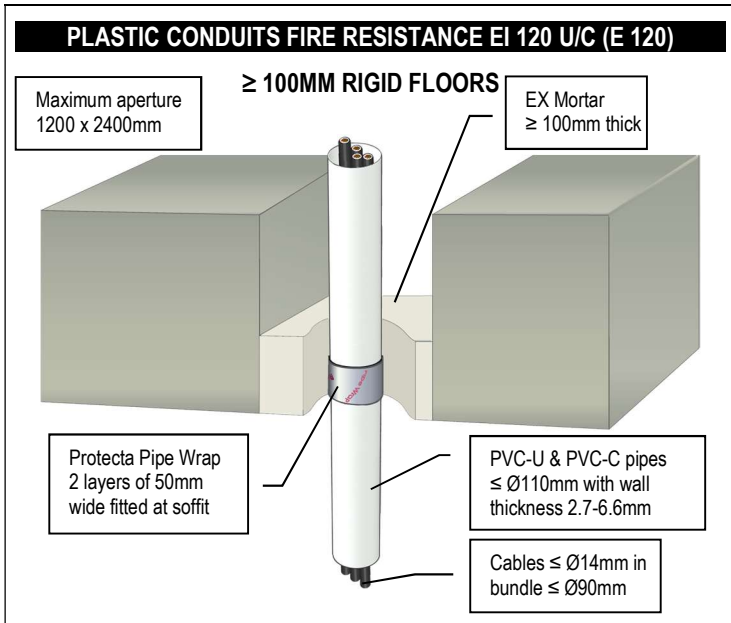

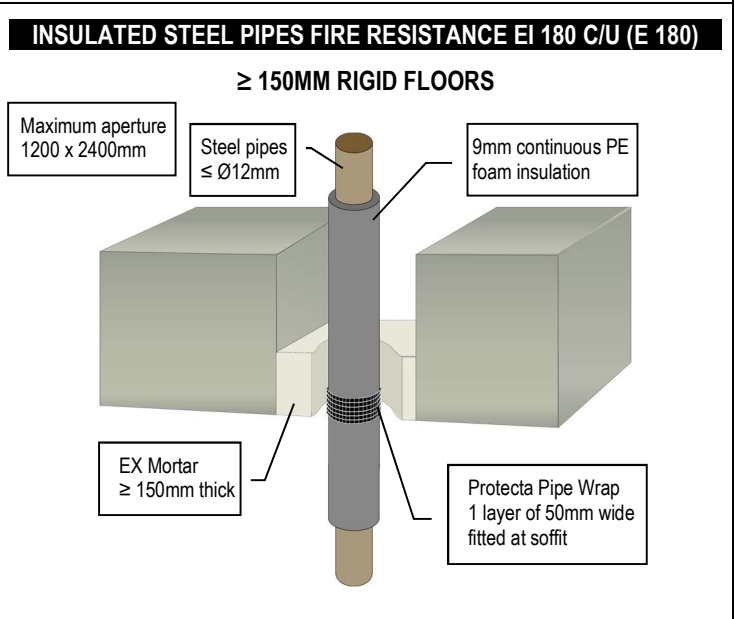
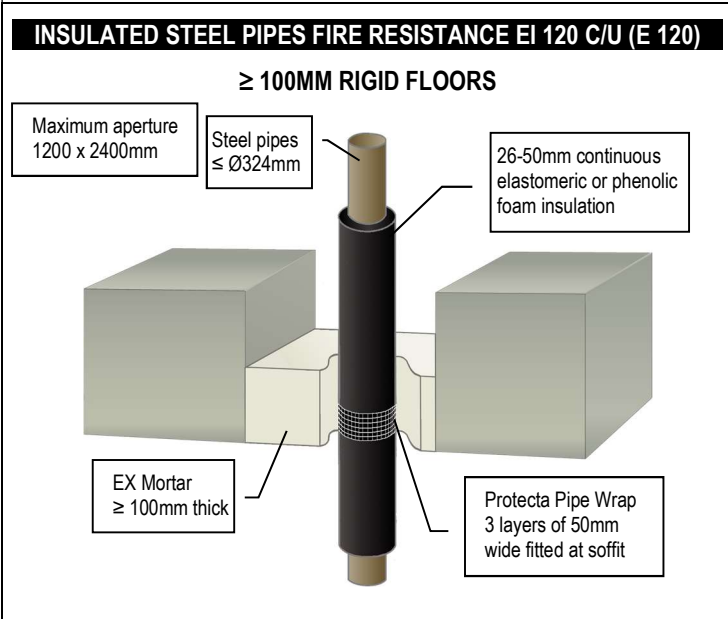
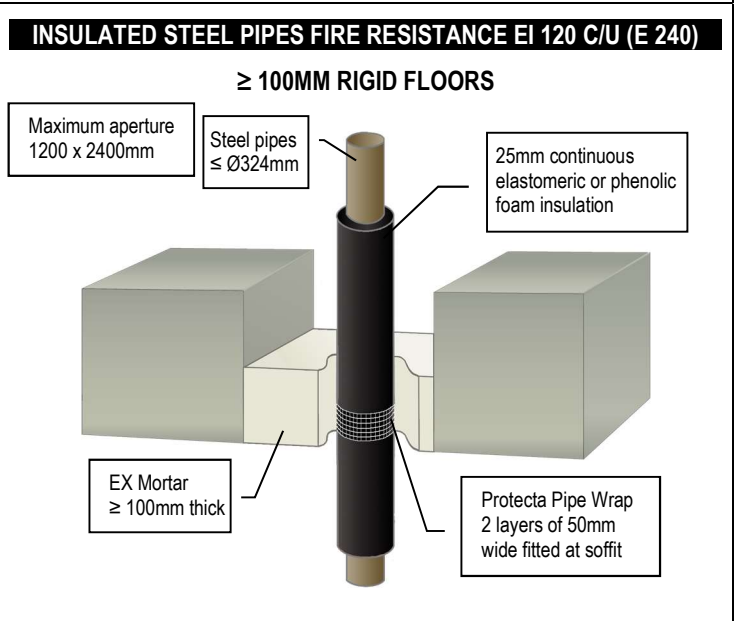
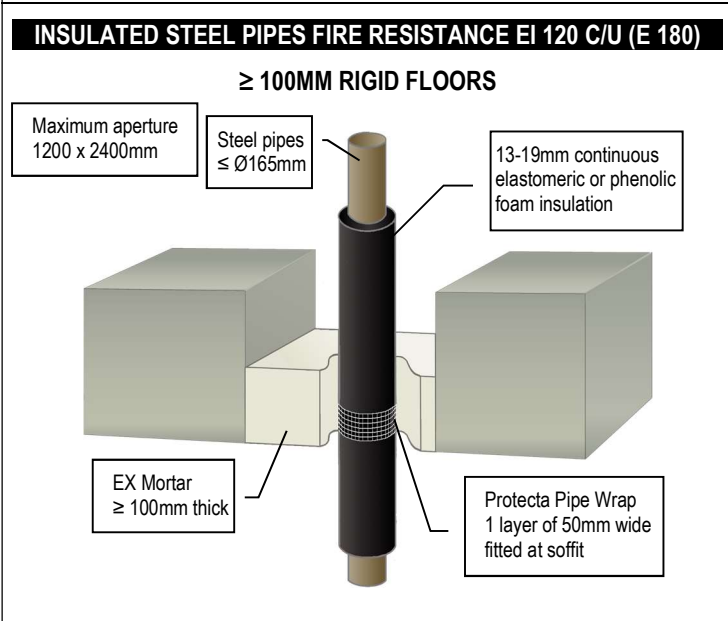
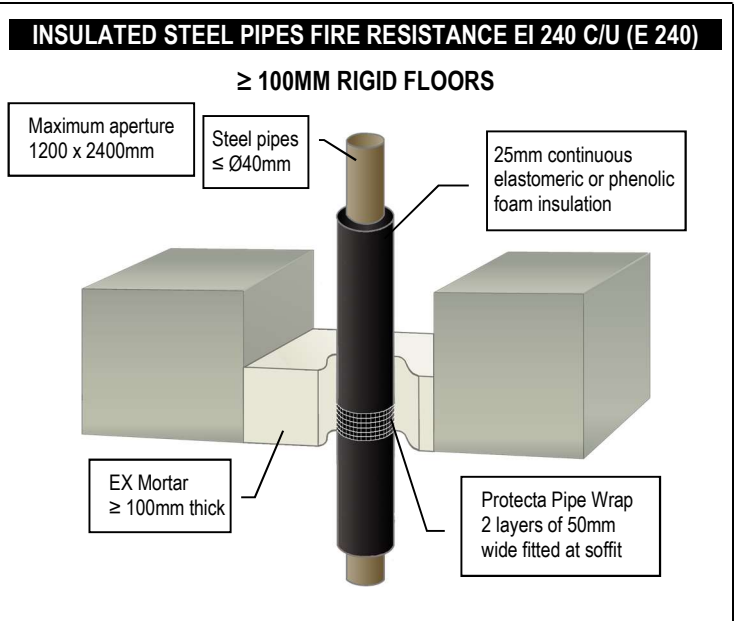
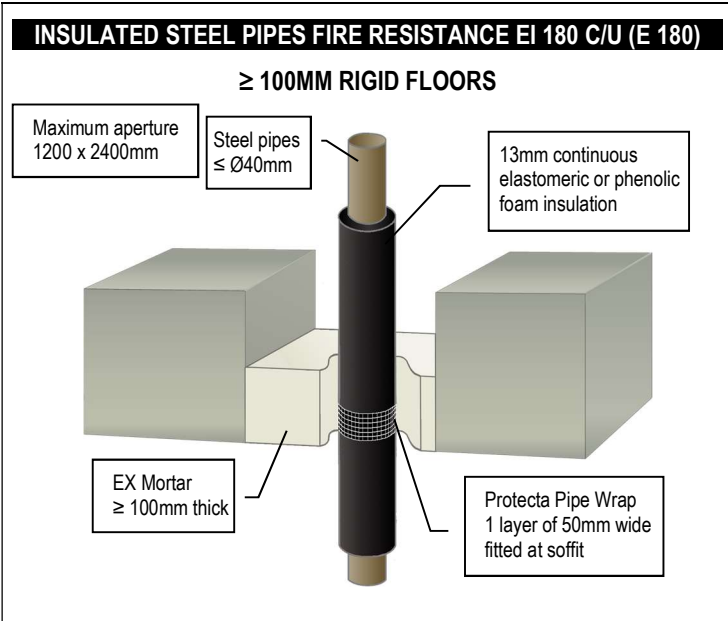

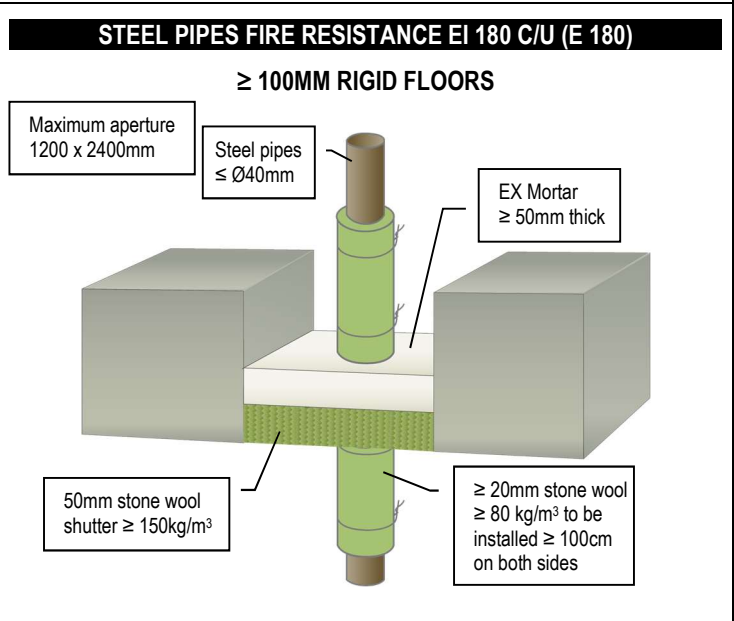
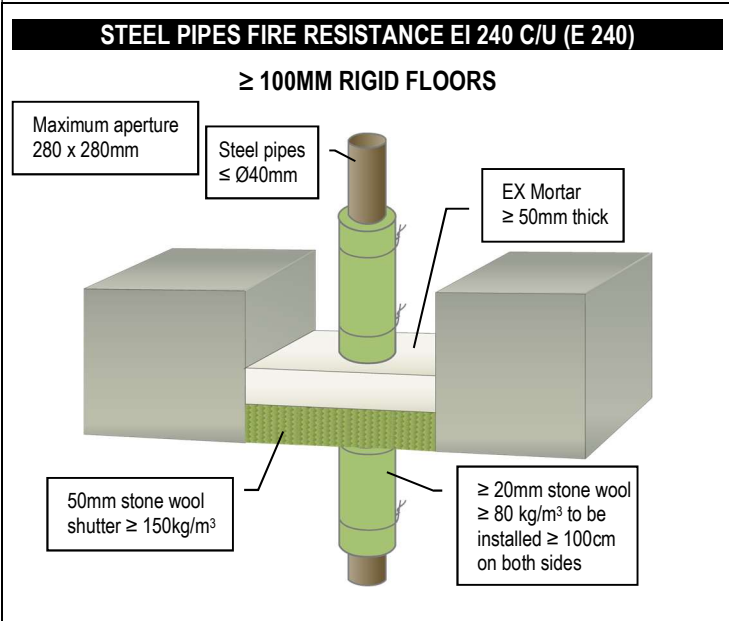
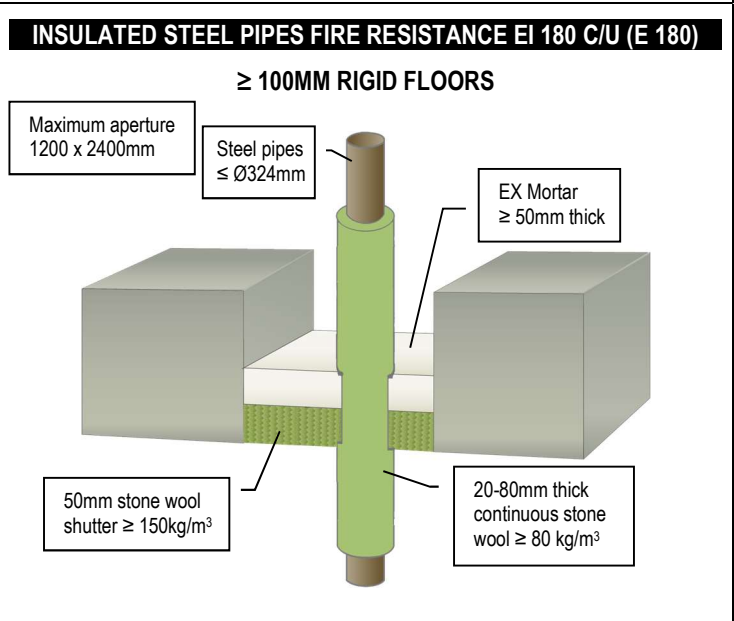
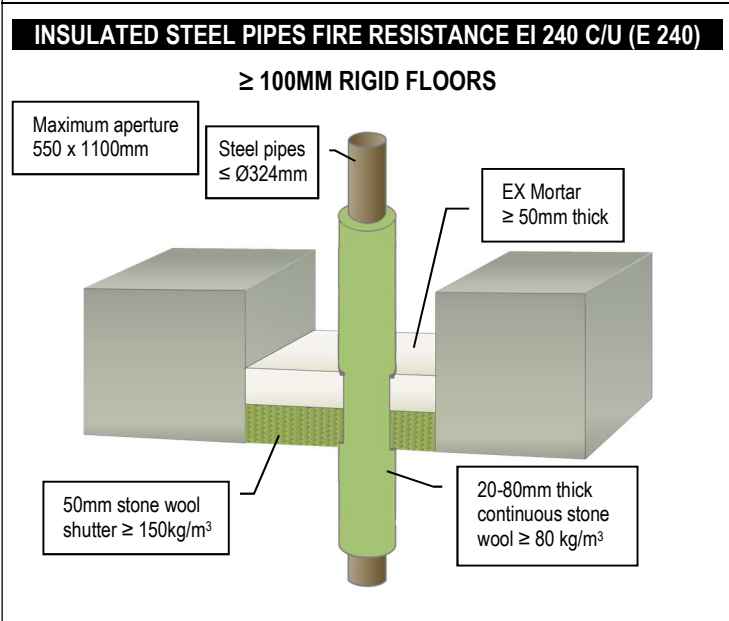
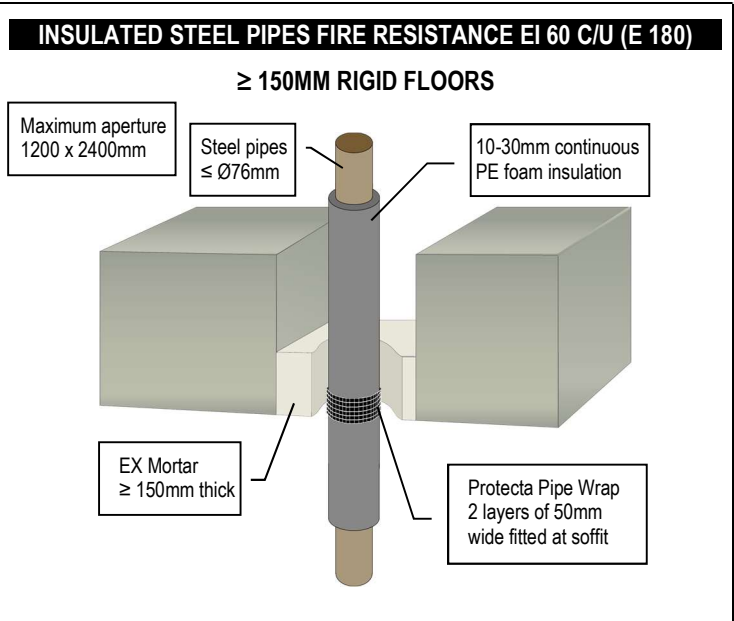
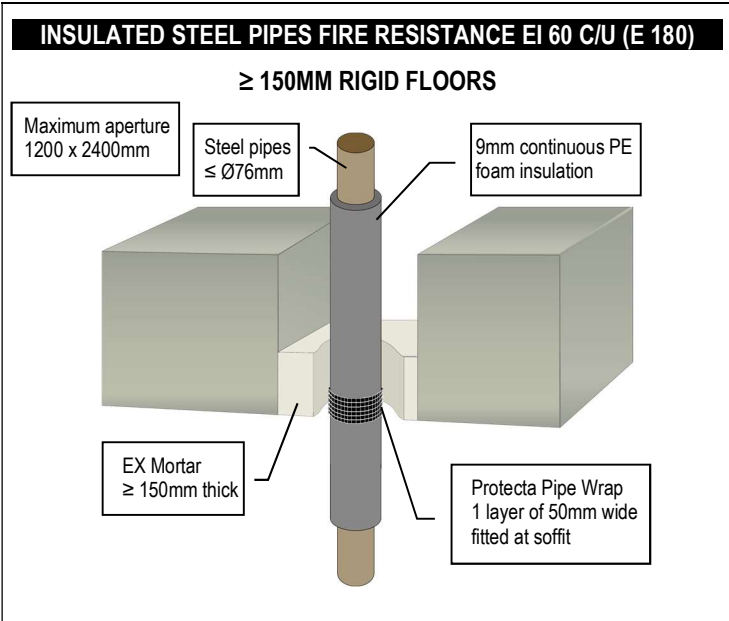

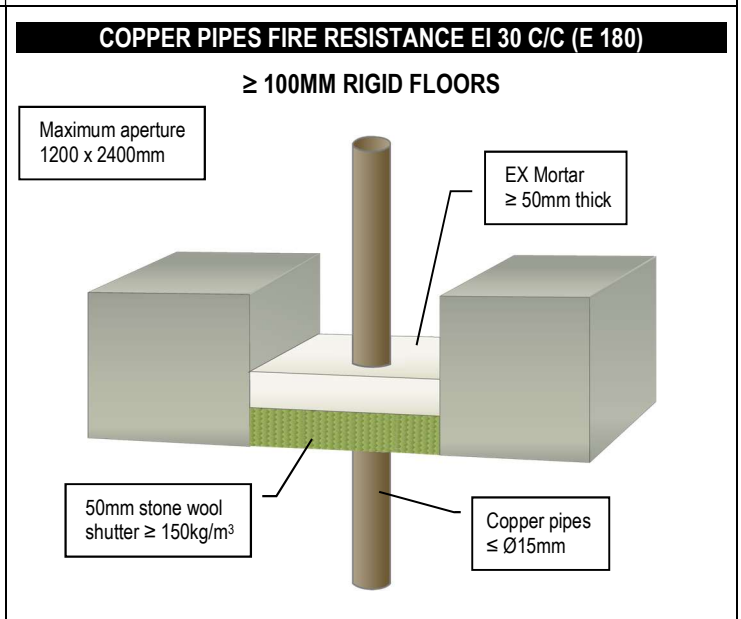
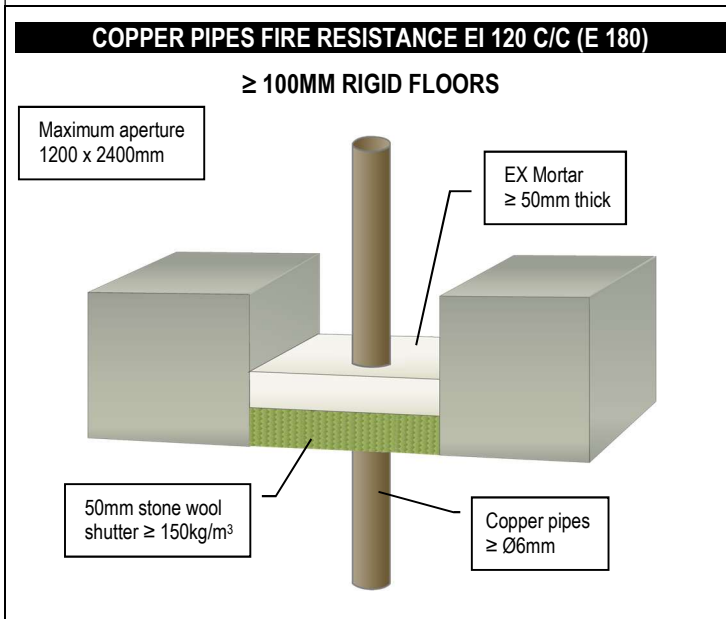
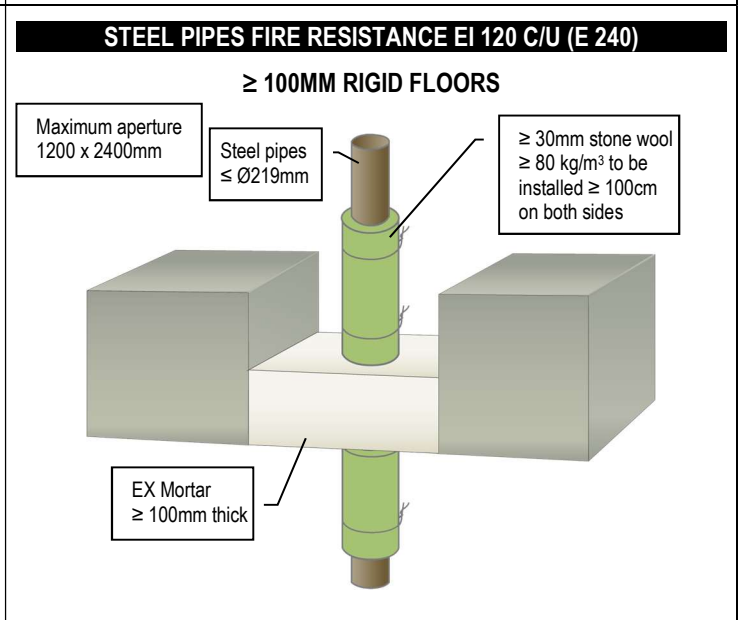
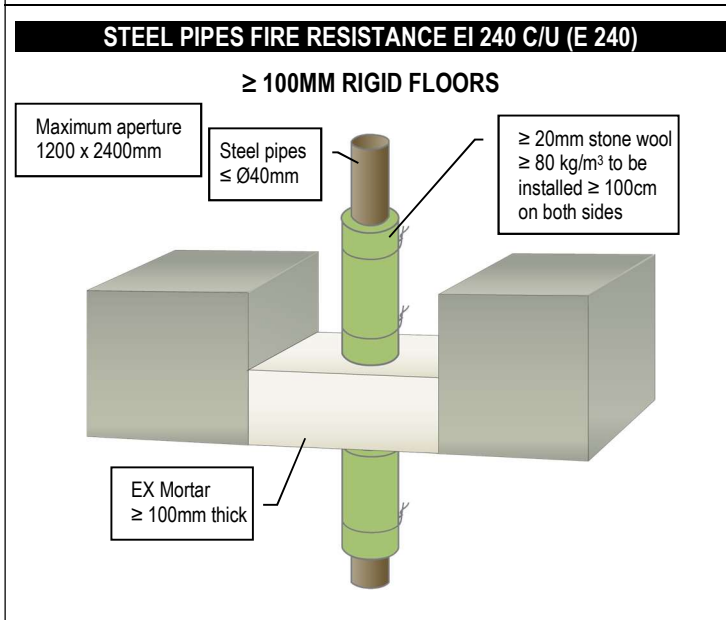
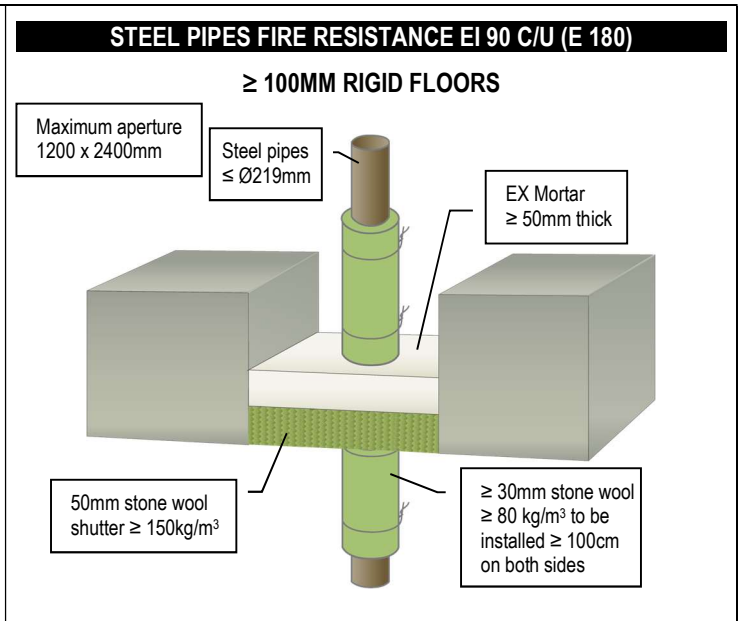
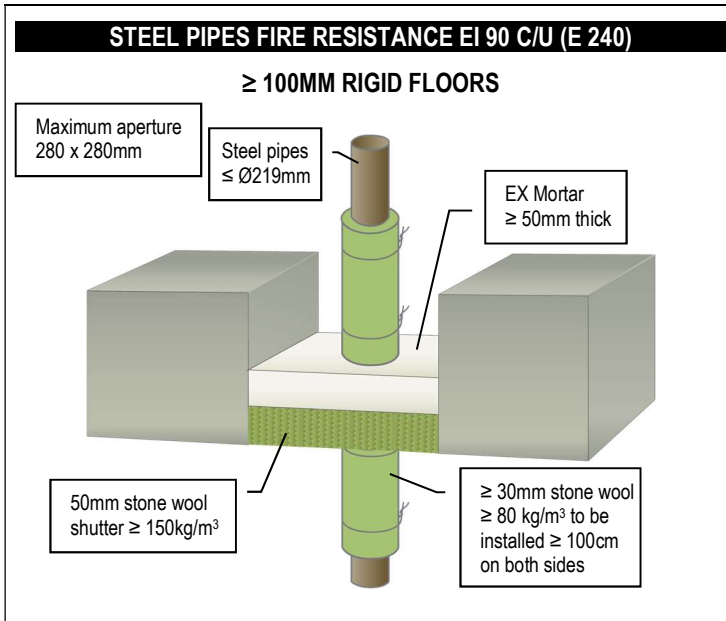

**COPPER PIPES FIRE RESISTANCE E 180 C/C**

≥ 100MM RIGID FLOORS

Maximum aperture  
1200 x 2400mm

EX Mortar  
≥ 50mm thick

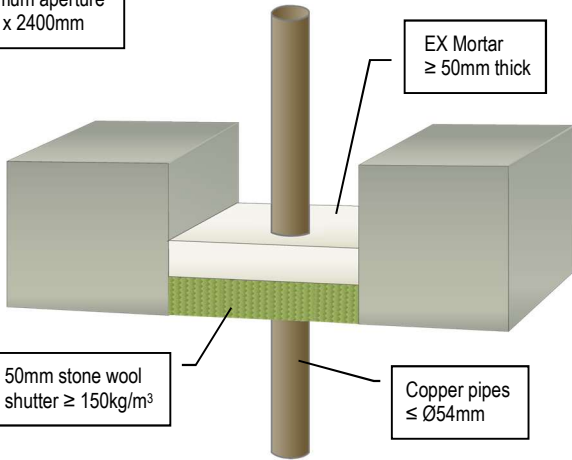

**COPPER PIPES FIRE RESISTANCE EI 180 C/C (E 240)**

≥ 120MM RIGID FLOORS

Maximum aperture  
1200 x 2400mm

Copper pipes  
≤ Ø12mm

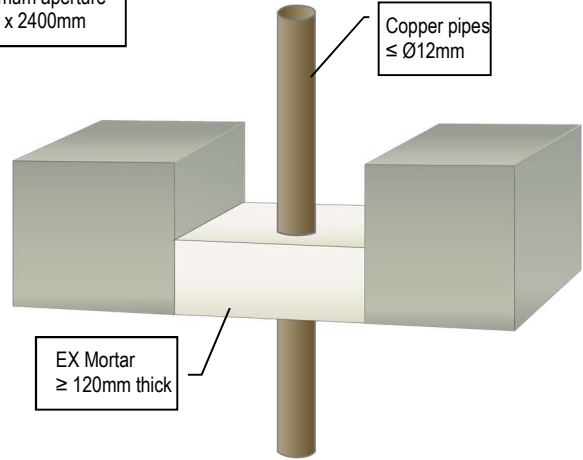

**COPPER OR STEEL PIPES FIRE RESISTANCE EI 20 C/C (E 180)**

≥ 100MM RIGID FLOORS

Maximum aperture  
1200 x 2400mm

Copper pipes  
≤ Ø54mm

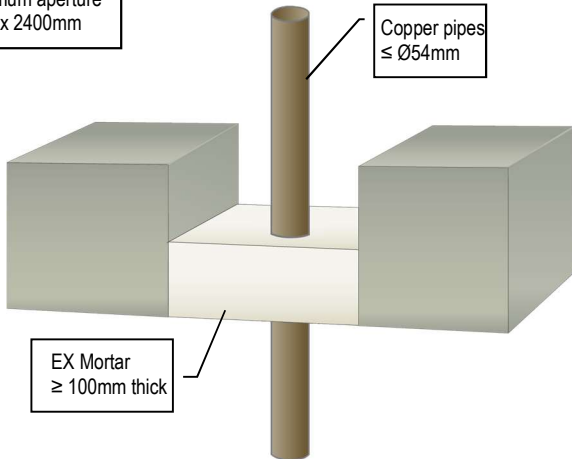

**INSULATED COPPER PIPES FIRE RESISTANCE EI 240 C/C (E 240)**

≥ 100MM RIGID FLOORS

Maximum aperture  
1200 x 2400mm

Copper pipes  
≤ Ø12mm

9mm continuous  
elastomeric or phenolic  
foam insulation

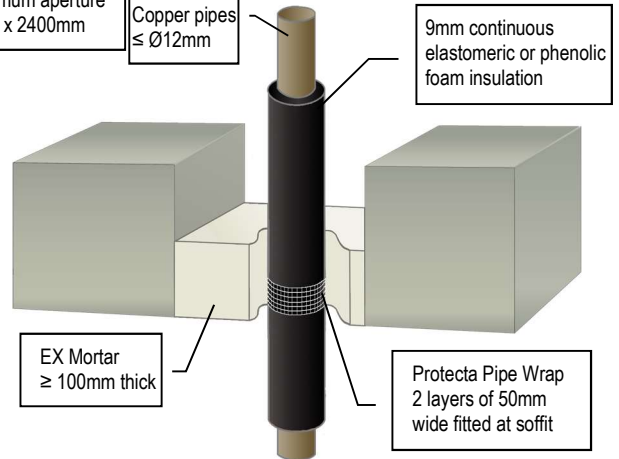

**INSULATED COPPER PIPES FIRE RESISTANCE EI 60 C/C (E 240)**

≥ 100MM RIGID FLOORS

Maximum aperture  
1200 x 2400mm

Copper pipes  
≤ Ø54mm

13-25mm continuous  
elastomeric or phenolic  
foam insulation

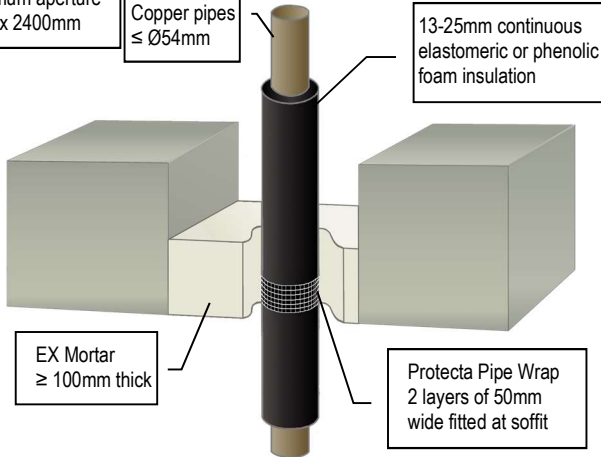

**INSULATED COPPER PIPES FIRE RESISTANCE EI 120 C/C (E 180)**

≥ 100MM RIGID FLOORS

Maximum aperture  
1200 x 2400mm

Copper pipes  
≤ Ø54mm

EX Mortar  
≥ 50mm thick

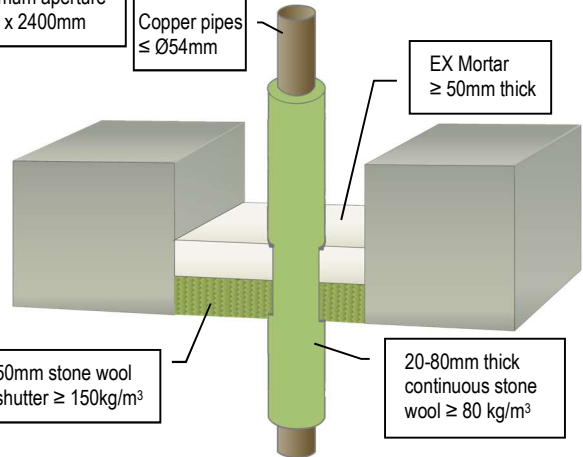



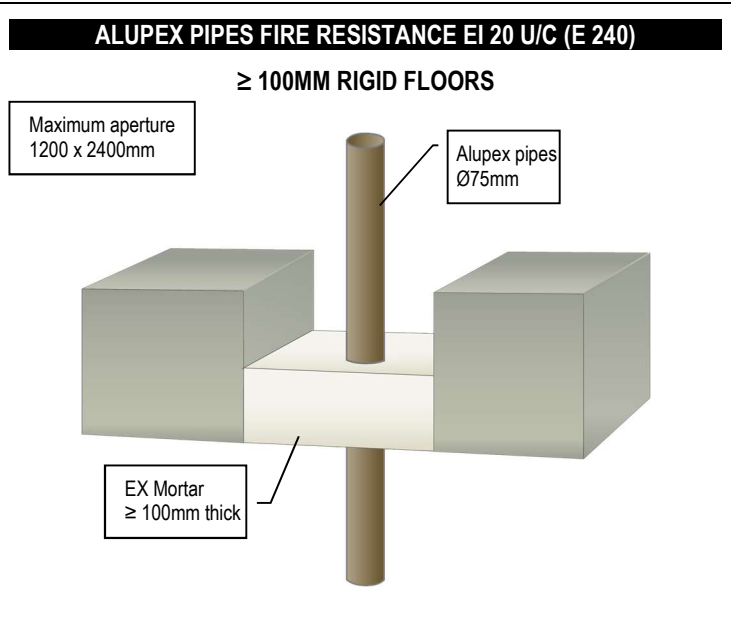
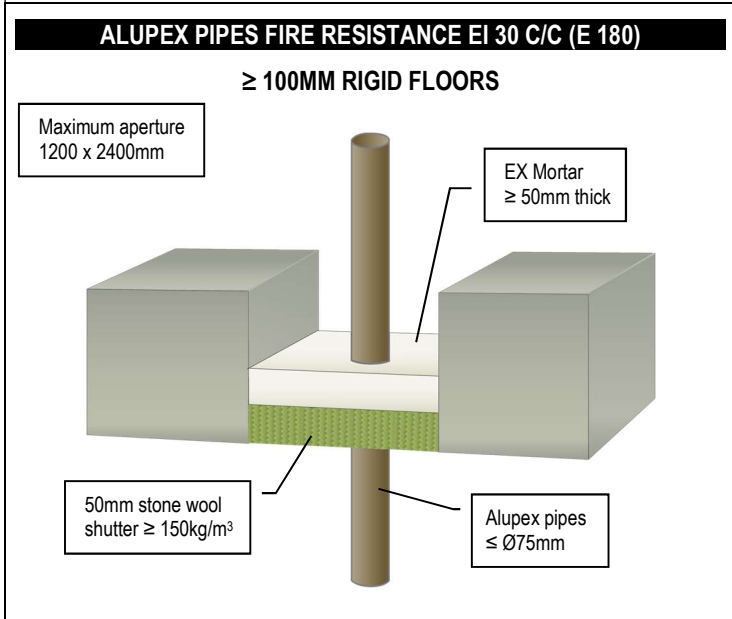
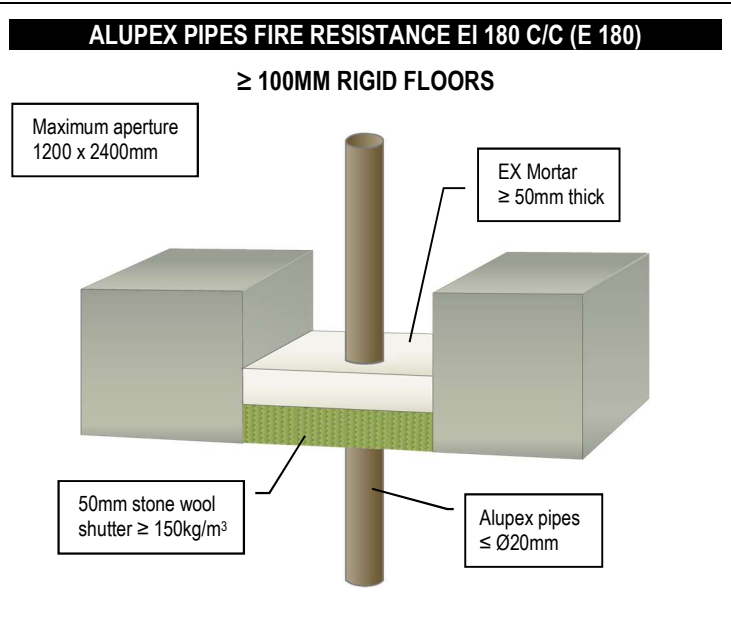
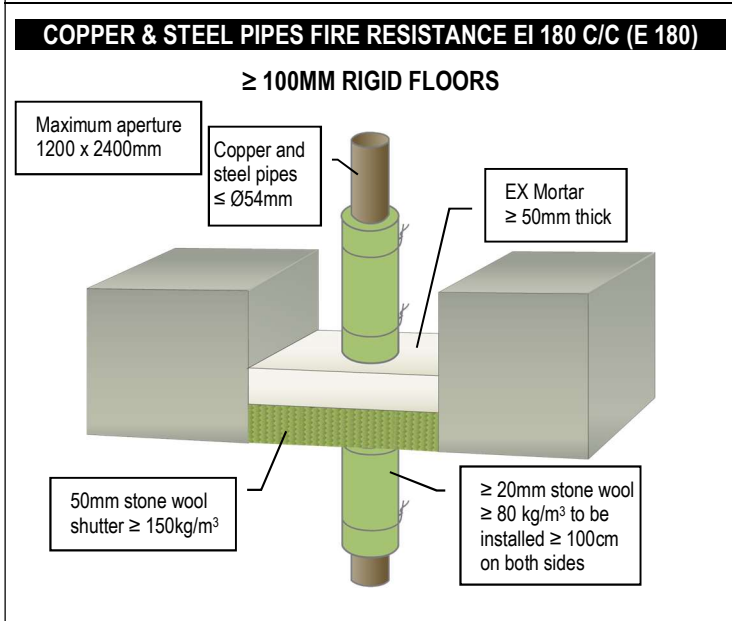
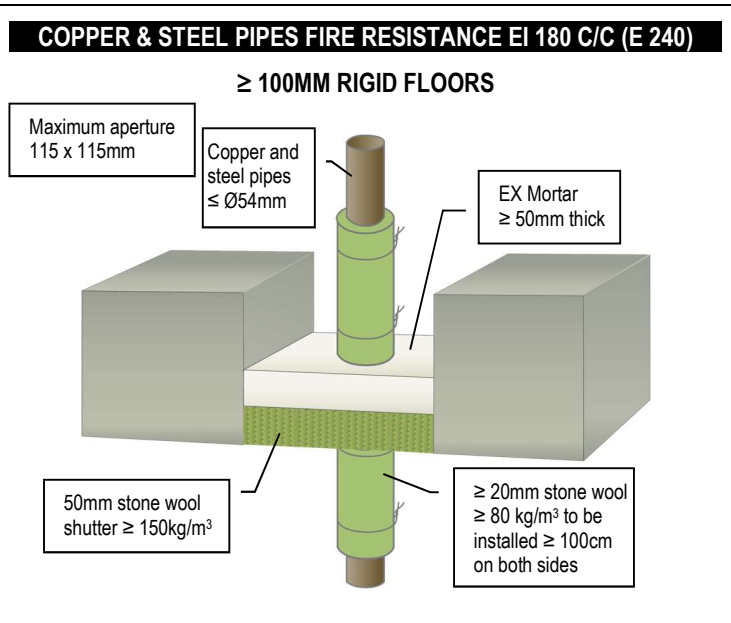
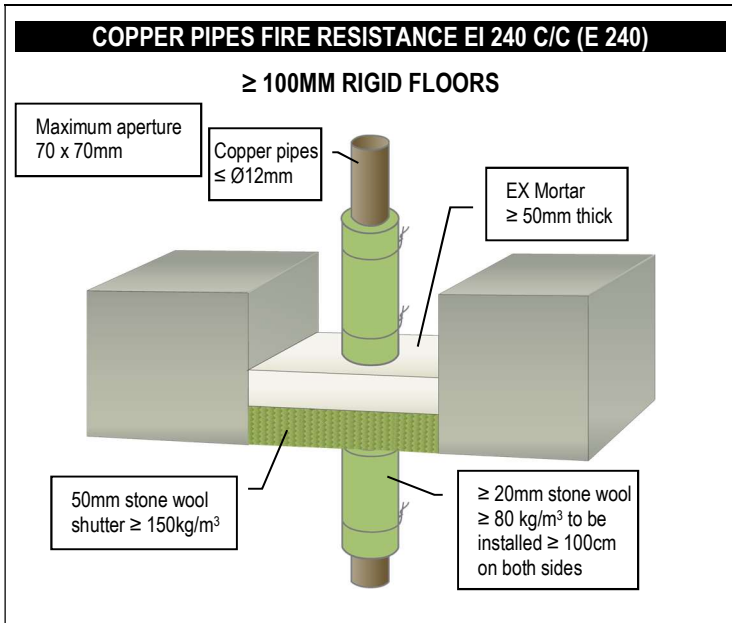

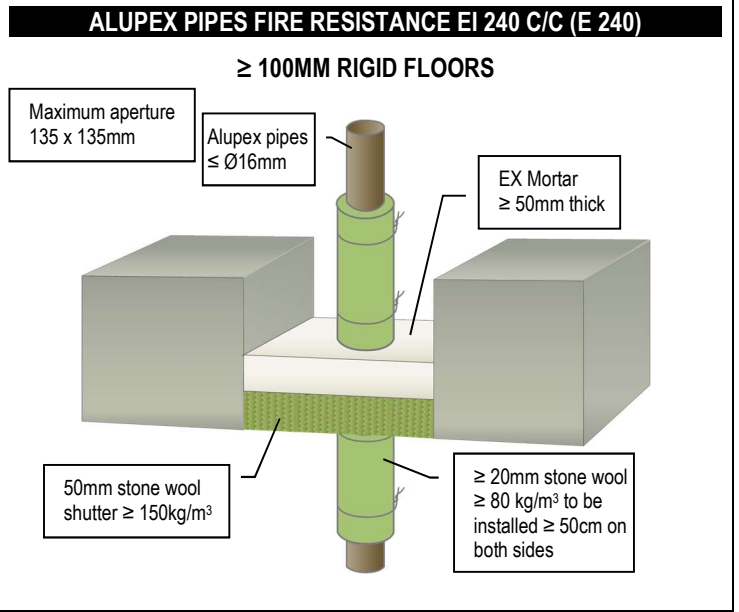
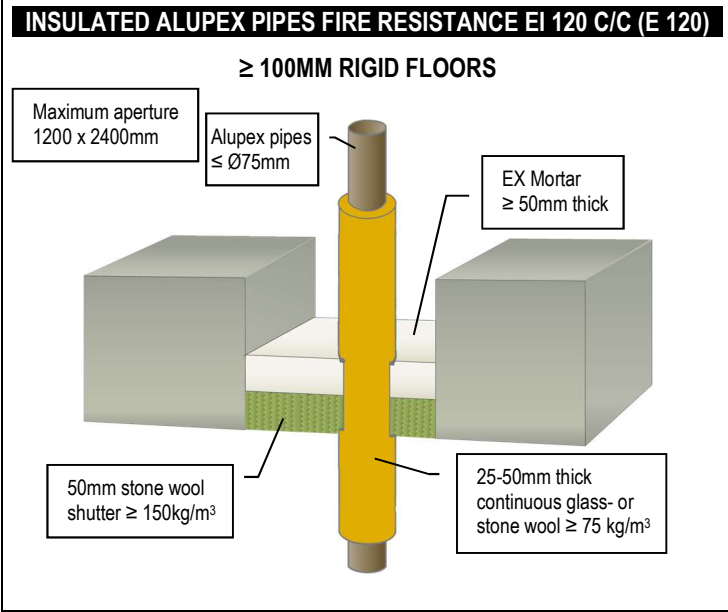
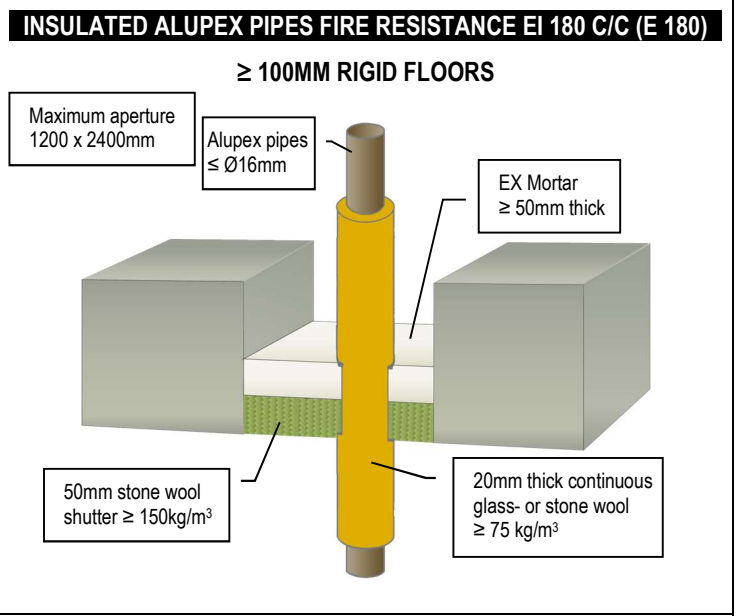
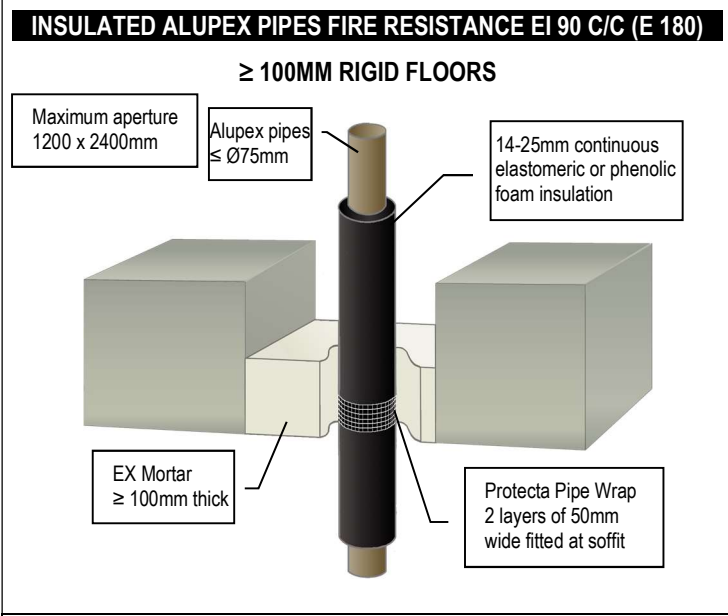
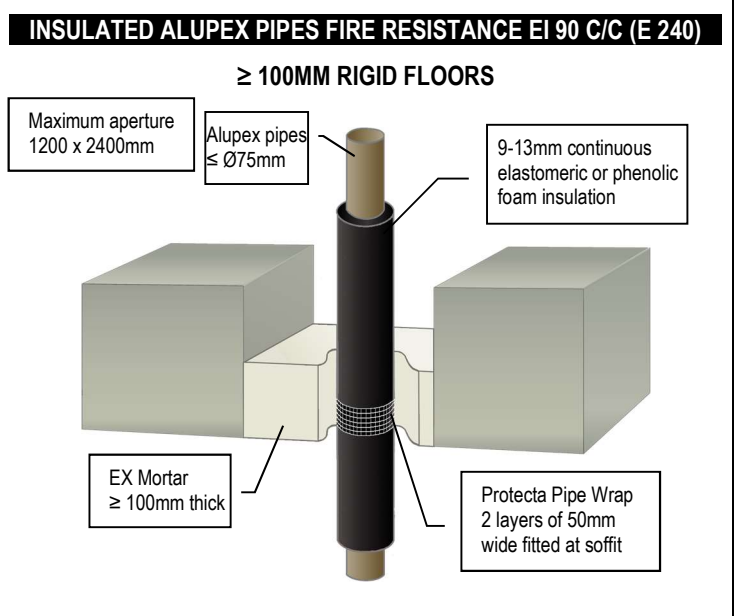
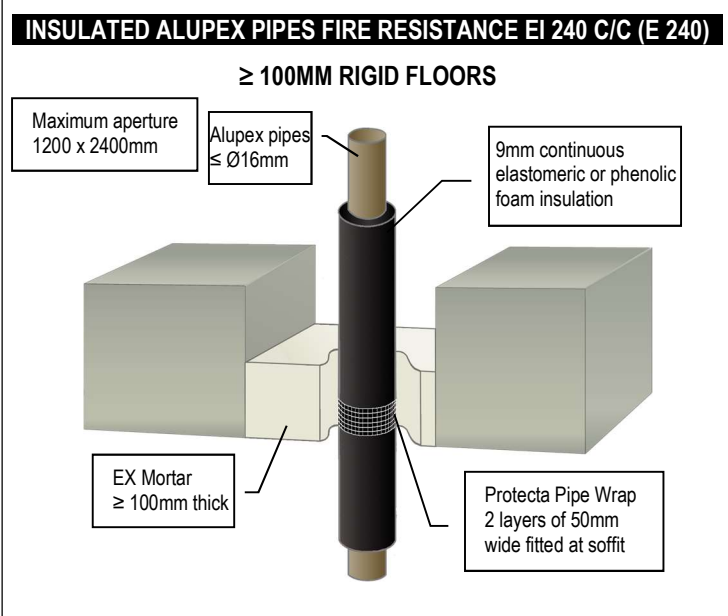

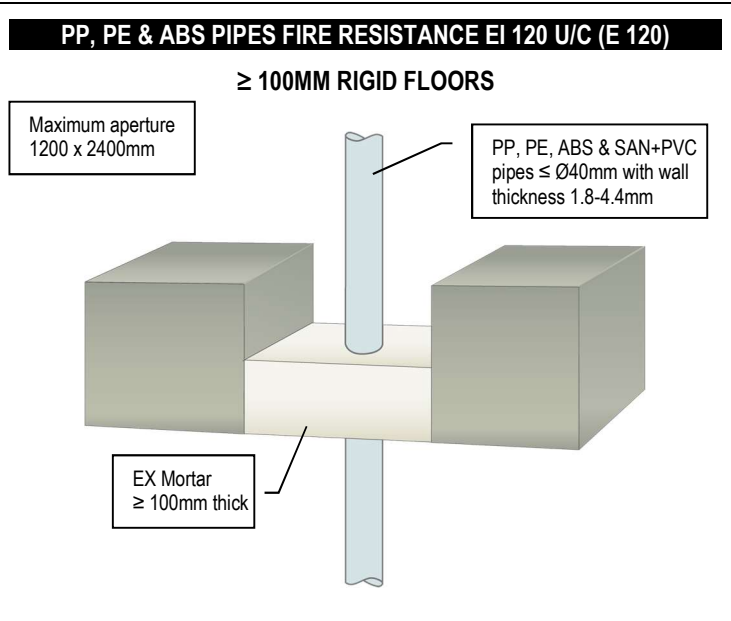
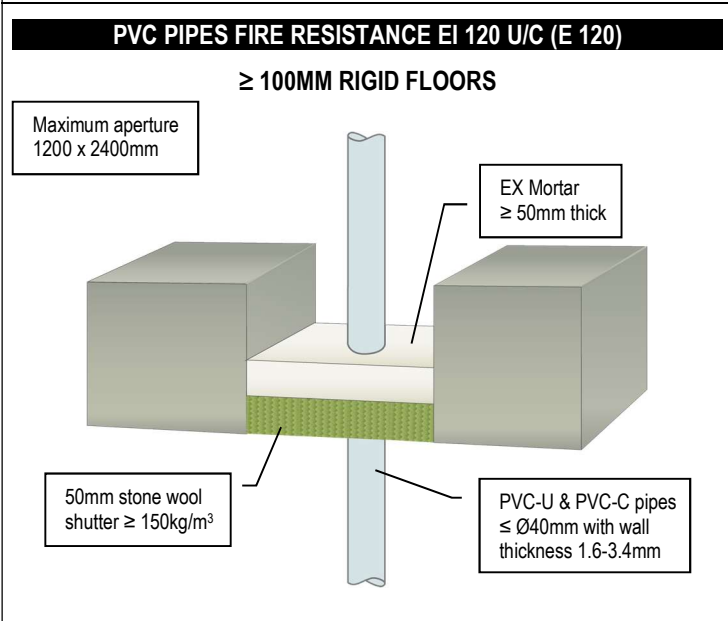
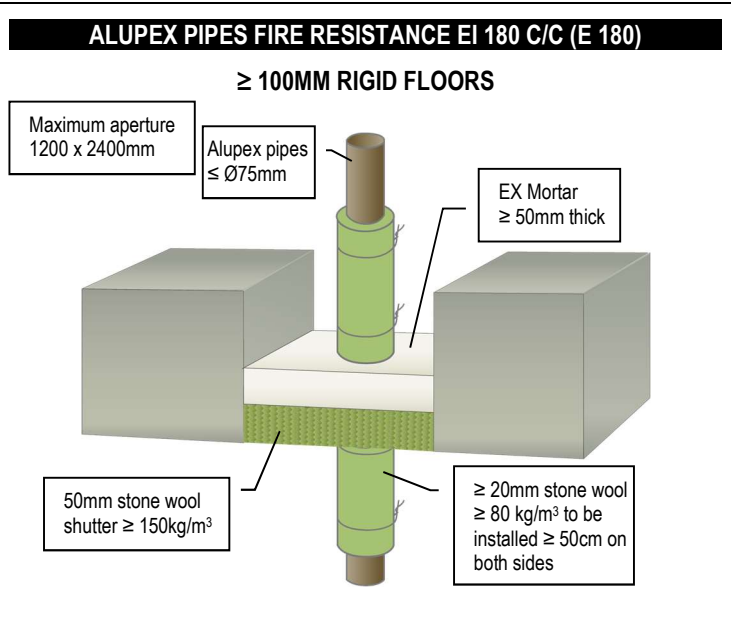
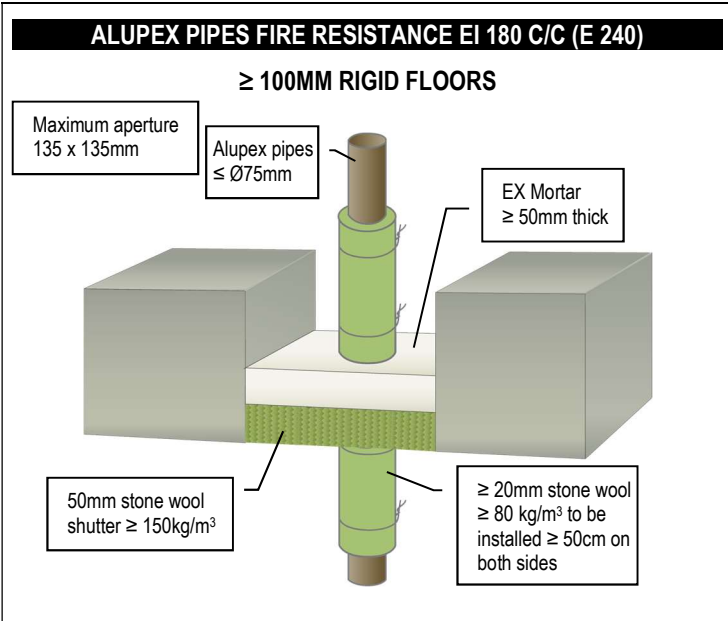

### PLASTIC PIPES IN U/C & C/C CONFIGURATIONS

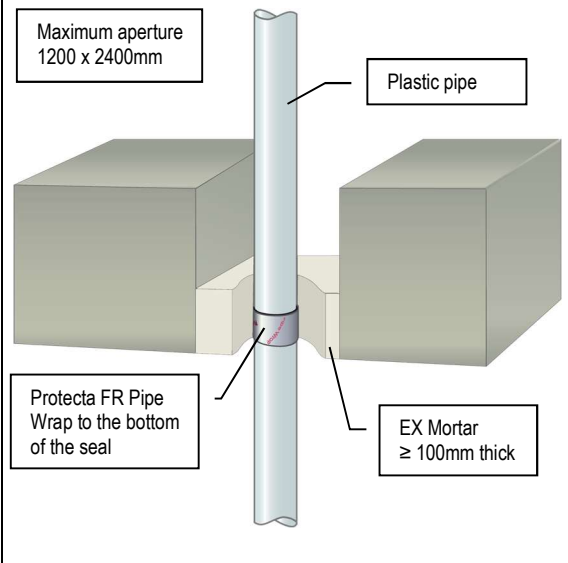

Services	Pipe Wall Thickness	Pipe Wrap	Classification
≤ Ø40mm PVC-U & PVC-C	1.8 – 3.7mm	50 x 1.8mm (1 layer)	EI 120 U/U (E 180 U/U)
≤ Ø40mm PE, ABS & SAN+PVC	2.4 – 3.7mm	50 x 1.8mm (1 layer)	EI 240 U/U (E 240 U/U)
≤ Ø40mm PP	1.8 – 5.5mm	50 x 1.8mm (1 layer)	EI 120 U/U (E 120 U/U)
≤ Ø110mm PVC-U & PVC-C	1.9 – 6.6mm	50 x 3.6mm (2 layers)	EI 240 U/C (E 240 U/C)
≤ Ø110mm PE, ABS & SAN+PVC	2.5 – 10.0mm	50 x 3.6mm (2 layers)	EI 120 U/C (E 120 U/C)
≤ Ø110mm PP	1.9 – 6.3mm	50 x 3.6mm (2 layers)	EI 240 U/C (E 240 U/C)
≤ Ø125mm PVC-U & PVC-C	3.5 – 7.4mm	50 x 7.2mm (4 layers)	EI 120 U/C (E 120 U/C)
≤ Ø125mm PE, ABS & SAN+PVC	3.9 – 11.4mm	50 x 7.2mm (4 layers)	EI 240 U/C (E 240 U/C)
≤ Ø125mm PP	3.4 – 11.4mm	50 x 7.2mm (4 layers)	EI 240 U/C (E 240 U/C)
≤ Ø160mm PVC-U & PVC-C	4.5 – 9.5mm	50 x 10.8mm (6 layers)	EI 90 C/C (E 90 C/C)
≤ Ø160mm PVC-U & PVC-C	4.5mm	50 x 10.8mm (6 layers)	EI 240 C/C (E 240 C/C)
≤ Ø160mm PVC-U & PVC-C	9.5mm	50 x 10.8mm (6 layers)	EI 90 U/C (E 90 U/C)
≤ Ø160mm PE, ABS & SAN+PVC	4.9 – 14.6mm	50 x 10.8mm (6 layers)	EI 120 U/C (E 120 U/C)
≤ Ø160mm PP	4.9 – 14.6mm	50 x 10.8mm (6 layers)	EI 240 U/C (E 240 U/C)

**PLASTIC PIPES IN U/U CONFIGURATION**

**≥ 150MM RIGID FLOORS**

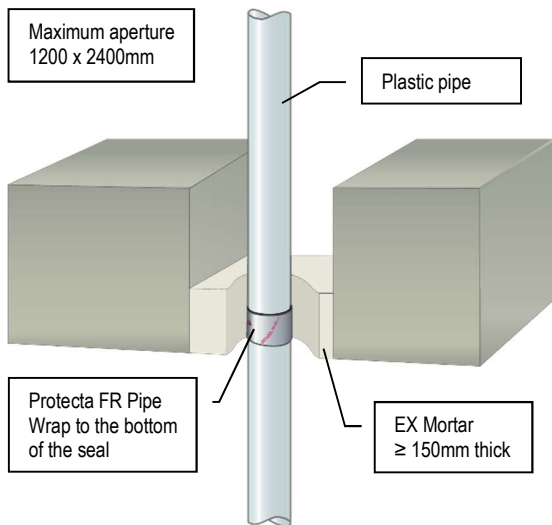

Services	Pipe Wall Thickness	Pipe Wrap	Classification
≤ Ø40mm PVC-U & PVC-C	1.8 – 3.7mm	50 x 1.8mm (1 layer)	EI 120 U/U (E 180 U/U)
≤ Ø40mm PE, ABS & SAN+PVC	2.4 – 3.7mm	50 x 1.8mm (1 layer)	EI 240 U/U (E 240 U/U)
≤ Ø40mm PP	1.8 – 5.5mm	50 x 1.8mm (1 layer)	EI 120 U/U (E 120 U/U)
≤ Ø110mm PVC-U & PVC-C	1.8 – 6.8mm	50 x 7.2mm (4 layers)	EI 60 U/U (E 60 U/U)
≤ Ø110mm PE, ABS & SAN+PVC	3.4 – 10.0mm	75 x 5.4mm (3 layers)	EI 240 U/U (E 240 U/U)
≤ Ø110mm PP	3.7 – 10.5mm	50 x 7.2mm (4 layers)	EI 240 U/U (E 240 U/U)
≤ Ø125mm PVC-U & PVC-C	1.8 – 7.4mm	50 x 7.2mm (4 layers)	EI 60 U/U (E 60 U/U)
Ø125mm PVC-U & PVC-C	7.4mm	50 x 7.2mm (4 layers)	EI 120 U/U (E 120 U/U)
Ø125mm PE, ABS & SAN+PVC	11.4mm	50 x 7.2mm (4 layers)	EI 240 U/U (E 240 U/U)
Ø125mm PP	11.4mm	50 x 7.2mm (4 layers)	EI 240 U/U (E 240 U/U)
Ø140mm PVC-U & PVC-C	6.5 – 8.3mm	75 x 10.8mm (6 layers)	EI 30 U/U (E 120 U/U)
Ø140mm PE, ABS & SAN+PVC	8.0 – 12.4mm	75 x 10.8mm (6 layers)	EI 120 U/U (E 240 U/U)
Ø140mm PP	12.8mm	75 x 7.2mm (4 layers)	EI 240 U/U (E 240 U/U)
≤ Ø160mm PVC-U & PVC-C	4.8 – 9.5mm	75 x 10.8mm (6 layers)	EI 30 U/U (E 120 U/U)
≤ Ø160mm PE, ABS & SAN+PVC	4.9 – 14.6mm	75 x 7.2mm (4 layers)	EI 120 U/U (E 120 U/U)
≤ Ø160mm PE, ABS & SAN+PVC	3.9 – 14.6mm	75 x 18.0mm (10 layers)	EI 120 U/U (E 240 U/U)
Ø160mm PP	14.6mm	75 x 7.2mm (4 layers)	EI 240 U/U (E 240 U/U)

**LARGE PVC PLASTIC PIPES**

**≥ 120MM RIGID FLOORS**

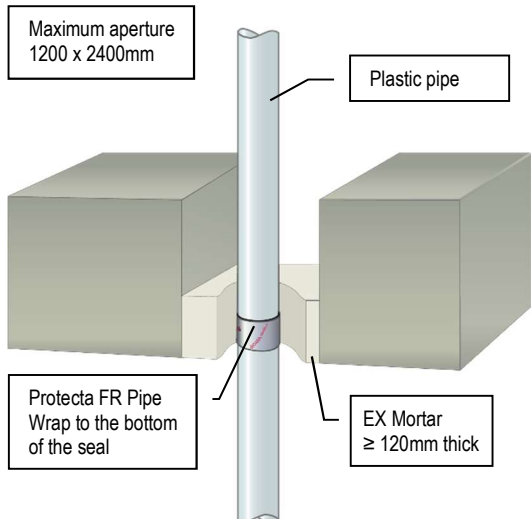

Services	Pipe Wall Thickness	Pipe Wrap	Classification
Ø160mm PVC-U & PVC-C	4.5 – 9.5mm	50 x 10.8mm (6 layers)	EI 120 U/C (E 120 U/C)
Ø161-199mm PVC-U & PVC-C	4.5 – 11.9mm	75 x 10.8mm (6 layers)	EI 120 C/C (E 120 C/C)
Ø200mm PVC-U & PVC-C	4.9 – 11.9mm	75 x 10.8mm (6 layers)	EI 240 C/C (E 240 C/C)
Ø201-314mm PVC-U & PVC-C	4.9 – 11.9mm	75 x 18.0mm (10 layers)	EI 120 C/C (E 120 C/C)
Ø315mm PVC-U & PVC-C	7.7mm	75 x 18.0mm (10 layers)	EI 120 C/C (E 120 C/C)
Ø315mm PVC-U & PVC-C	7.8 – 12.1mm	75 x 18.0mm (10 layers)	EI 90 C/C (E 90 C/C)
Ø316-399mm PVC-U & PVC-C	7.7 – 15.3mm	75 x 28.8mm (16 layers)	EI 60 C/C (E 60 C/C)
Ø400mm PVC-U & PVC-C	15.3mm	75 x 28.8mm (16 layers)	EI 60 C/C (E 60 C/C)

**LARGE PE PLASTIC PIPES**

**RIGID FLOORS**

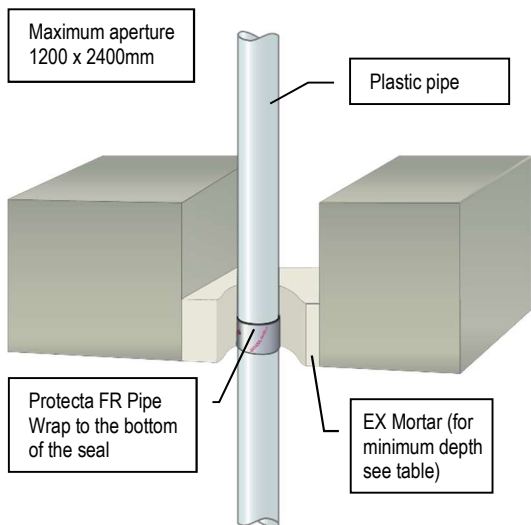

Services	Pipe Wall Thickness	Mortar & Floor Depth	Pipe Wrap	Classification
Ø161-199mm PE, ABS, SAN+PVC	4.9 – 18.2mm	150mm	75 x 10.8mm (6 layers)	EI 120 C/C (E 120 C/C)
Ø200mm PE, ABS & SAN+PVC	6.2 – 18.2mm	120mm	75 x 10.8mm (6 layers)	EI 240 C/C (E 240 C/C)
Ø250mm PE, ABS & SAN+PVC	7.8mm	100mm	75 x 12.6mm (7 layers)	EI 180 C/C (E 180 C/C)
Ø201-315mm PE, ABS, SAN+PVC	4.9 – 18.7mm	150mm	75 x 18.0mm (10 layers)	EI 60 C/C (E 60 C/C)

**LARGE PP PLASTIC PIPES**

**RIGID FLOORS**

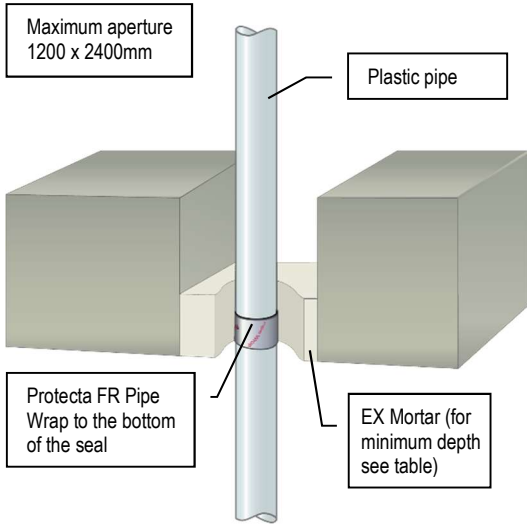

Services	Pipe Wall Thickness	Mortar & Floor Depth	Pipe Wrap	Classification
Ø161-200mm PP	4.9 – 18.2mm	120mm	75 x 10.8mm (6 layers)	EI 240 C/C (E 240 C/C)
Ø201-315mm PP	4.9 – 7.7mm	150mm	75 x 18.0mm (10 layers)	EI 180 C/C (E 180 C/C)
Ø201-315mm PP	7.8 – 28.6mm	150mm	75 x 18.0mm (10 layers)	EI 60 C/C (E 60 C/C)
Ø316-399mm PP	7.7 – 28.6mm	150mm	75 x 28.8mm (16 layers)	EI 60 C/C (E 60 C/C)
Ø400mm PP	22.7mm	150mm	75 x 28.8mm (16 layers)	EI 60 C/C (E 60 C/C)

**COMPOSITE AQUATHERM GREEN SDR9 PLASTIC PIPES FIRE RESISTANCE EI 240**

**≥ 100MM RIGID FLOORS**

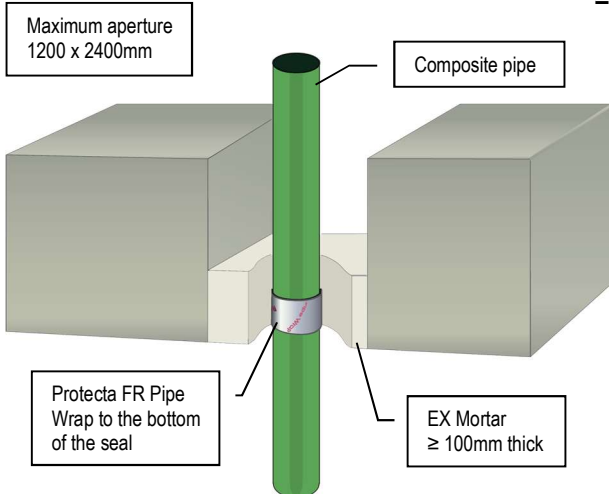

Services	FR Pipe Wrap	Classification
Ø 32mm Aquatherm Green SDR9 pipes	50 x 1.8mm (1 layer)	EI 240 C/C (E 240 C/C)
Ø 40mm Aquatherm Green SDR9 pipes	50 x 3.6mm (2 layers)	EI 240 C/C (E 240 C/C)
Ø 50mm Aquatherm Green SDR9 pipes	50 x 3.6mm (2 layers)	EI 240 C/C (E 240 C/C)
Ø 63mm Aquatherm Green SDR9 pipes	50 x 3.6mm (2 layers)	EI 240 C/C (E 240 C/C)
Ø 75mm Aquatherm Green SDR9 pipes	50 x 3.6mm (2 layers)	EI 240 C/C (E 240 C/C)
Ø 90mm Aquatherm Green SDR9 pipes	50 x 3.6mm (2 layers)	EI 240 C/C (E 240 C/C)
Ø 110mm Aquatherm Green SDR9 pipes	50 x 3.6mm (2 layers)	EI 240 C/C (E 240 C/C)

**COMPOSITE BLUEPOWER PLASTIC PIPES FIRE RESISTANCE EI 180 – 240**

**≥ 100MM RIGID FLOORS**

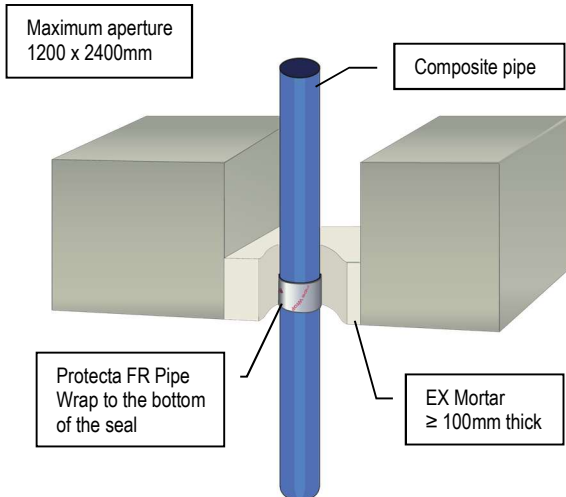

Services	FR Pipe Wrap	Classification
Ø 32mm BluePower pipes	50 x 3.6mm (2 layers)	EI 240 U/U (E 240 U/U)
Ø 40mm BluePower pipes	50 x 3.6mm (2 layers)	EI 240 U/U (E 240 U/U)
Ø 50mm BluePower pipes	50 x 3.6mm (2 layers)	EI 240 U/U (E 240 U/U)
Ø 75mm BluePower pipes	50 x 3.6mm (2 layers)	EI 120 U/C (E 120 U/C)
Ø 90mm BluePower pipes	50 x 3.6mm (2 layers)	EI 120 U/C (E 120 U/C)
Ø 110mm BluePower pipes	50 x 3.6mm (2 layers)	EI 120 U/C (E 120 U/C)
Ø 125mm BluePower pipes	50 x 7.2mm (4 layers)	EI 120 U/C (E 120 U/C)
Ø 160mm BluePower pipes	50 x 10.8mm (6 layers)	EI 240 U/C (E 240 U/C)

**COMPOSITE GEBERIT SILENT-PP PLASTIC PIPES FIRE RESISTANCE EI 120**

≥ 100MM RIGID FLOORS

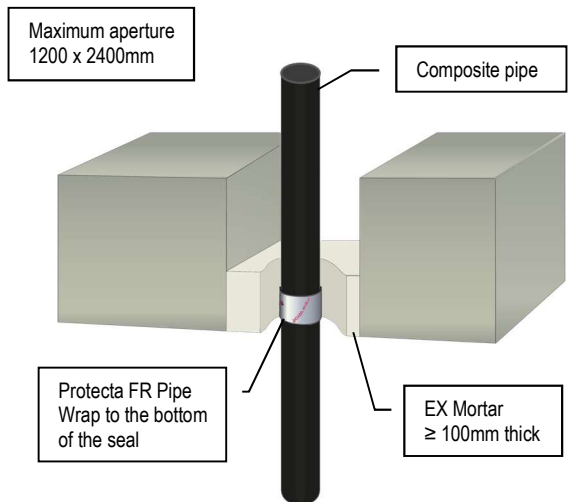

Services	FR Pipe Wrap	Classification
Ø 32mm Geberit Silent-PP pipes	50 x 3.6mm (2 layers)	EI 120 U/U (E 120 U/U)
Ø 40mm Geberit Silent-PP pipes	50 x 3.6mm (2 layers)	EI 120 U/U (E 120 U/U)
Ø 50mm Geberit Silent-PP pipes	50 x 3.6mm (2 layers)	EI 120 U/U (E 120 U/U)
Ø 75mm Geberit Silent-PP pipes	50 x 3.6mm (2 layers)	EI 120 U/C (E 120 U/C)
Ø 90mm Geberit Silent-PP pipes	50 x 3.6mm (2 layers)	EI 120 U/C (E 120 U/C)
Ø 110mm Geberit Silent-PP pipes	50 x 3.6mm (2 layers)	EI 120 U/C (E 120 U/C)

**COMPOSITE POLO-KAL NG PLASTIC PIPES FIRE RESISTANCE EI 180 – 240**

≥ 100MM RIGID FLOORS

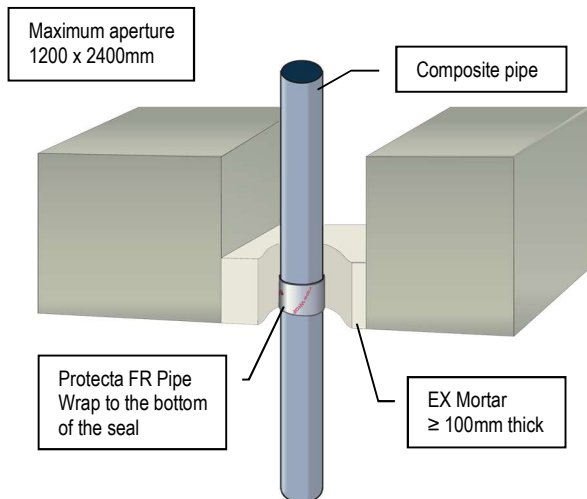

Services	FR Pipe Wrap	Classification
Ø 32mm Polo-Kal NG pipes	50 x 3.6mm (2 layers)	EI 180 U/C (E 180 U/C)
Ø 40mm Polo-Kal NG pipes	50 x 3.6mm (2 layers)	EI 180 U/C (E 180 U/C)
Ø 50mm Polo-Kal NG pipes	50 x 3.6mm (2 layers)	EI 180 U/C (E 180 U/C)
Ø 75mm Polo-Kal NG pipes	50 x 3.6mm (2 layers)	EI 180 U/C (E 180 U/C)
Ø 90mm Polo-Kal NG pipes	50 x 3.6mm (2 layers)	EI 180 U/C (E 180 U/C)
Ø 110mm Polo-Kal NG pipes	50 x 3.6mm (2 layers)	EI 180 U/C (E 180 U/C)
Ø 125mm Polo-Kal NG pipes	50 x 7.2mm (4 layers)	EI 240 U/C (E 240 U/C)
Ø 160mm Polo-Kal NG pipes	50 x 10.8mm (6 layers)	EI 240 U/C (E 240 U/C)

**COMPOSITE REHAU RAUPIANO PLUS PLASTIC PIPES FIRE RESISTANCE EI 120**

≥ 100MM RIGID FLOORS

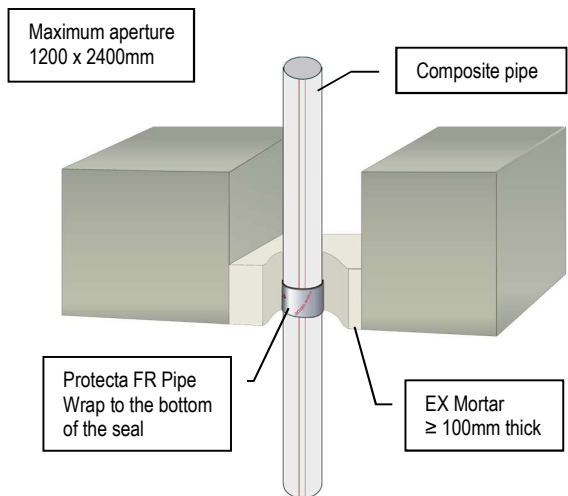

Services	FR Pipe Wrap	Classification
Ø 40mm Rehau Raupiano Plus pipes	50 x 3.6mm (2 layers)	EI 120 U/U (E 120 U/U)
Ø 50mm Rehau Raupiano Plus pipes	50 x 3.6mm (2 layers)	EI 120 U/U (E 120 U/U)
Ø 75mm Rehau Raupiano Plus pipes	50 x 3.6mm (2 layers)	EI 120 U/C (E 120 U/C)
Ø 90mm Rehau Raupiano Plus pipes	50 x 3.6mm (2 layers)	EI 120 U/C (E 120 U/C)
Ø 110mm Rehau Raupiano Plus pipes	50 x 3.6mm (2 layers)	EI 120 U/C (E 120 U/C)
Ø 125mm Rehau Raupiano Plus pipes	50 x 7.2mm (4 layers)	EI 120 U/C (E 240 U/C)
Ø 160mm Rehau Raupiano Plus pipes	50 x 10.8mm (6 layers)	EI 120 U/C (E 120 U/C)

**COMPOSITE UPONOR DECIBEL PLASTIC PIPES FIRE RESISTANCE EI 120**

**≥ 100MM RIGID FLOORS**

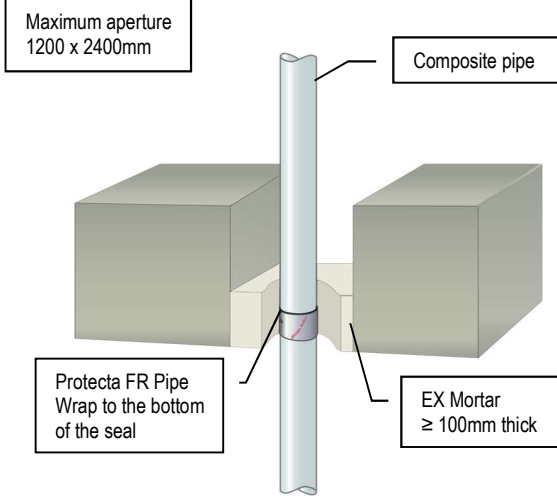

Services	FR Pipe Wrap	Classification
Ø 50mm Uponor Decibel pipes	50 x 3.6mm (2 layers)	EI 120 U/U (E 120 U/U)
Ø 75mm Uponor Decibel pipes	50 x 3.6mm (2 layers)	EI 120 U/C (E 120 U/C)
Ø 110mm Uponor Decibel pipes	50 x 3.6mm (2 layers)	EI 120 U/C (E 120 U/C)

**COMPOSITE WAVIN SITECH PLASTIC PIPES FIRE RESISTANCE EI 120**

**≥ 100MM RIGID FLOORS**

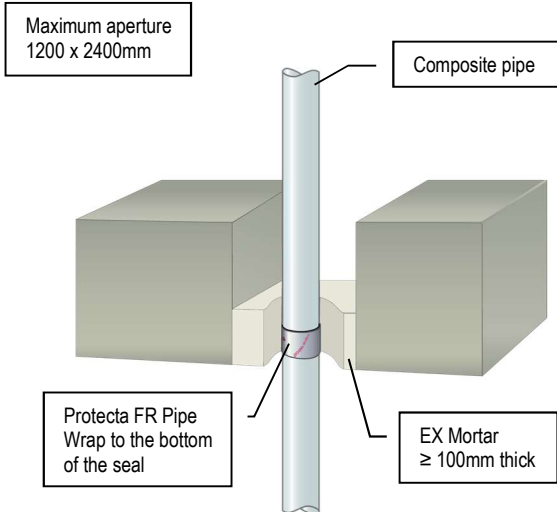

Services	FR Pipe Wrap	Classification
Ø 32mm Wavin SiTech pipes	50 x 3.6mm (2 layers)	EI 120 U/U (E 120 U/U)
Ø 40mm Wavin SiTech pipes	50 x 3.6mm (2 layers)	EI 120 U/U (E 120 U/U)
Ø 50mm Wavin SiTech pipes	50 x 3.6mm (2 layers)	EI 120 U/U (E 120 U/U)
Ø 75mm Wavin SiTech pipes	50 x 3.6mm (2 layers)	EI 120 U/C (E 120 U/C)
Ø 90mm Wavin SiTech pipes	50 x 3.6mm (2 layers)	EI 120 U/C (E 120 U/C)
Ø 110mm Wavin SiTech pipes	50 x 3.6mm (2 layers)	EI 120 U/C (E 120 U/C)

**INSULATED PE PIPES FIRE RESISTANCE EI 240 C/C (E 240)**

**≥ 120MM RIGID FLOORS**

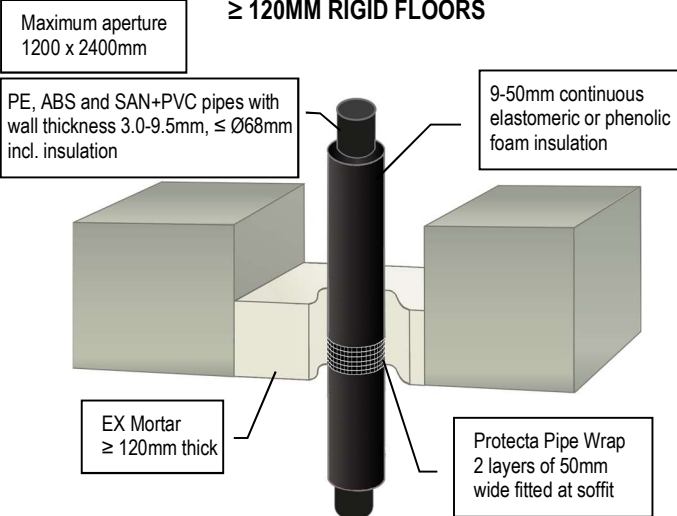

**INSULATED PE PIPES FIRE RESISTANCE EI 240 C/C (E 240)**

**≥ 120MM RIGID FLOORS**

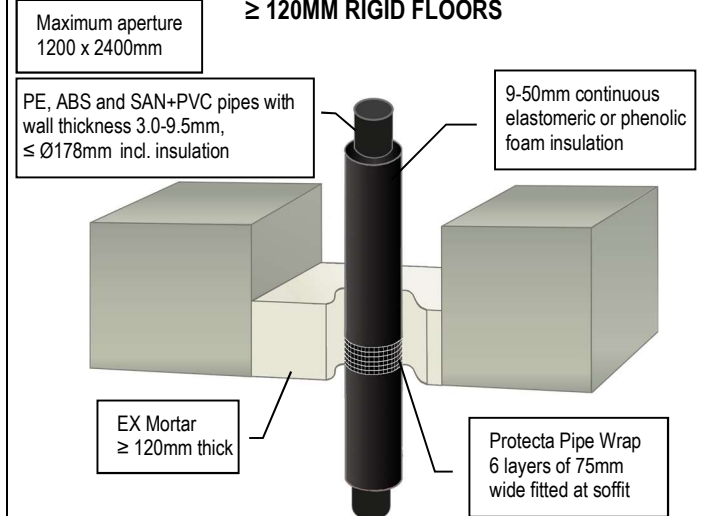

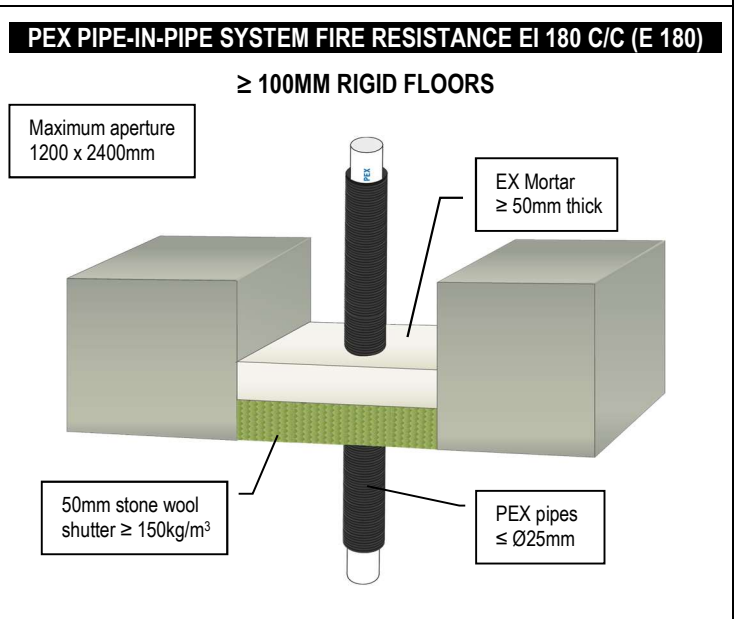
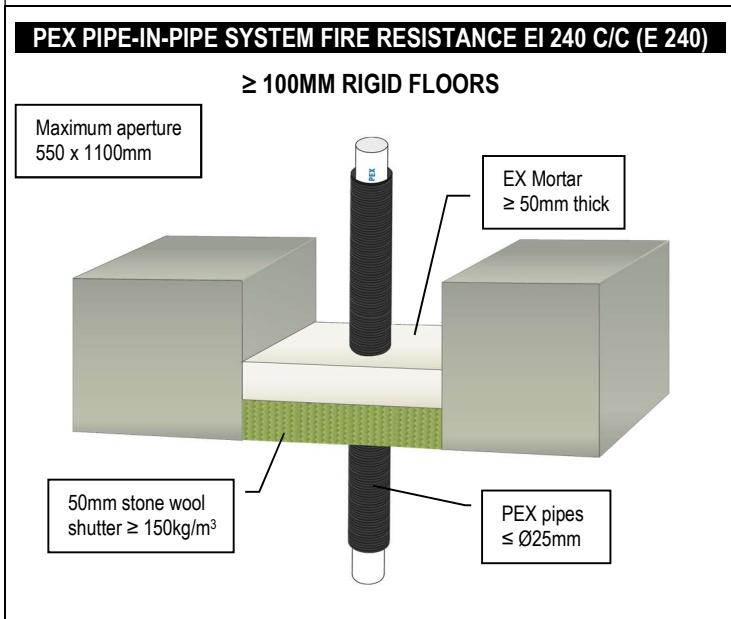
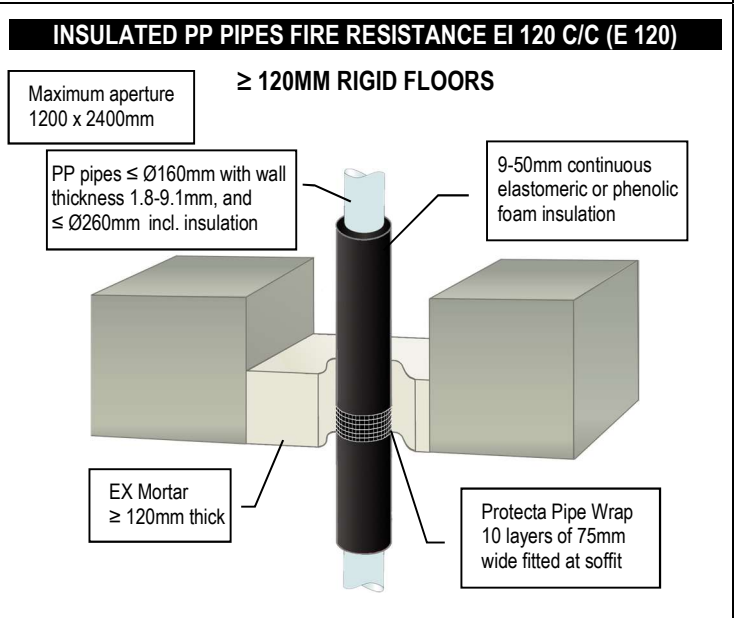
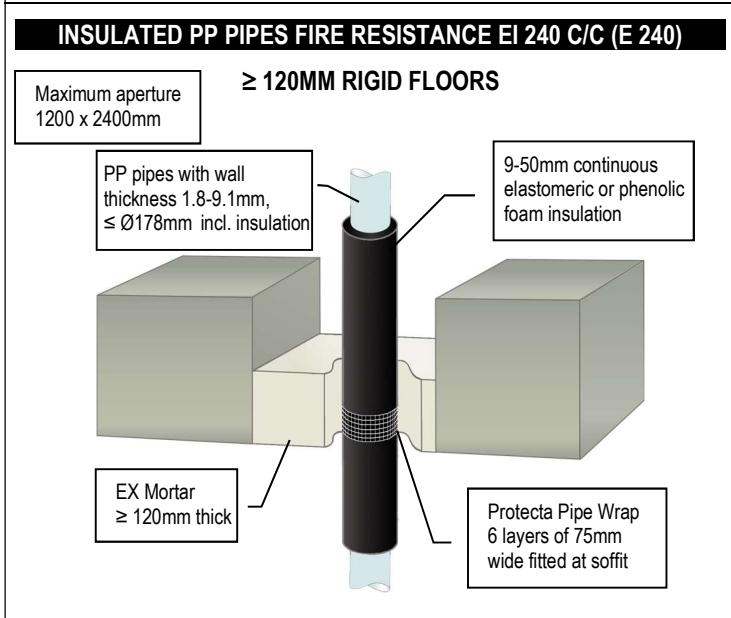
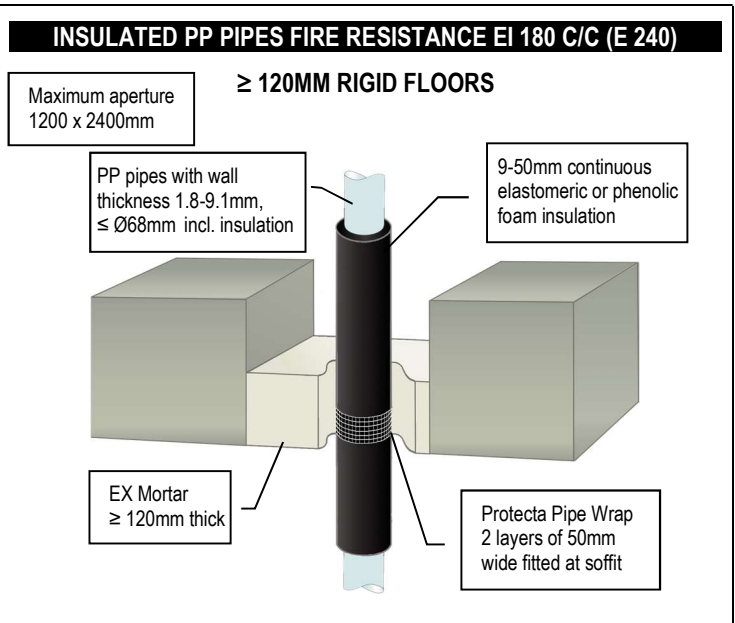
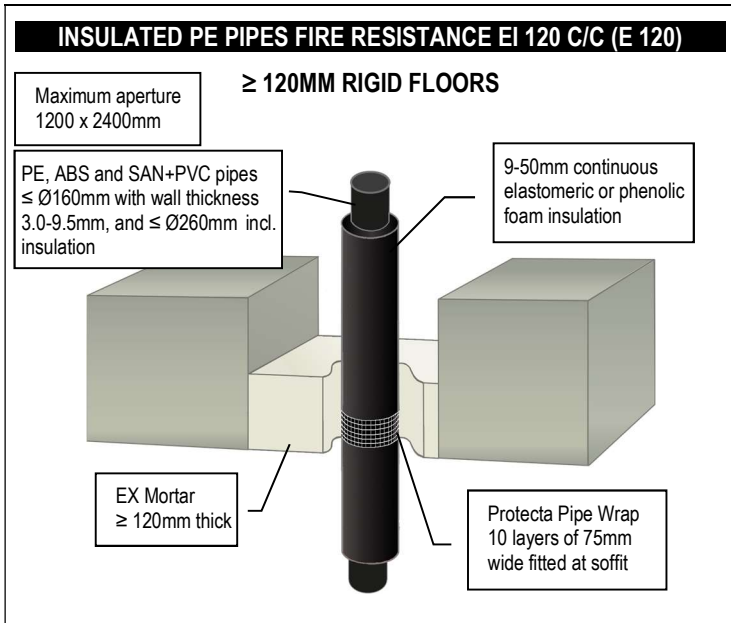



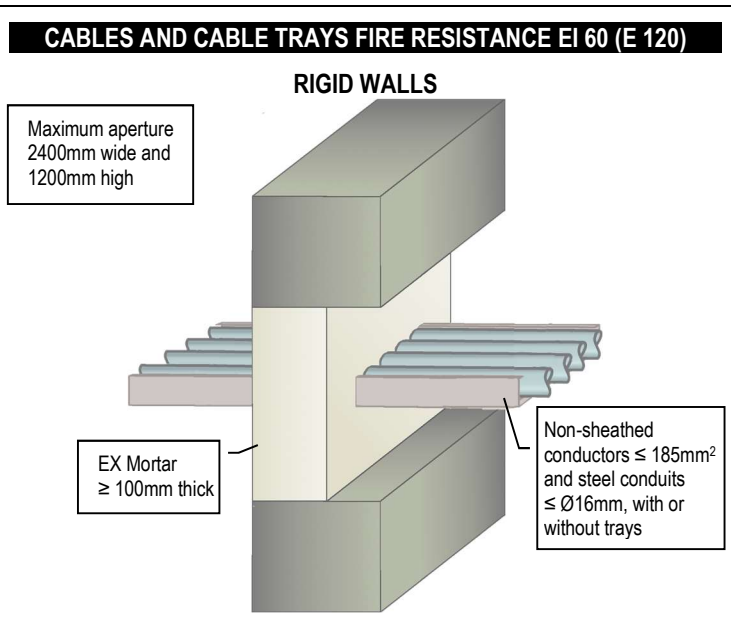
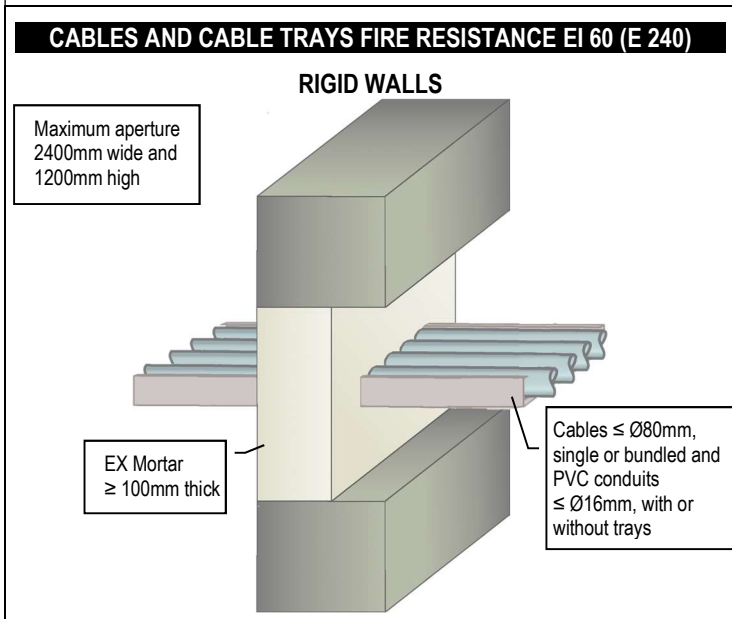
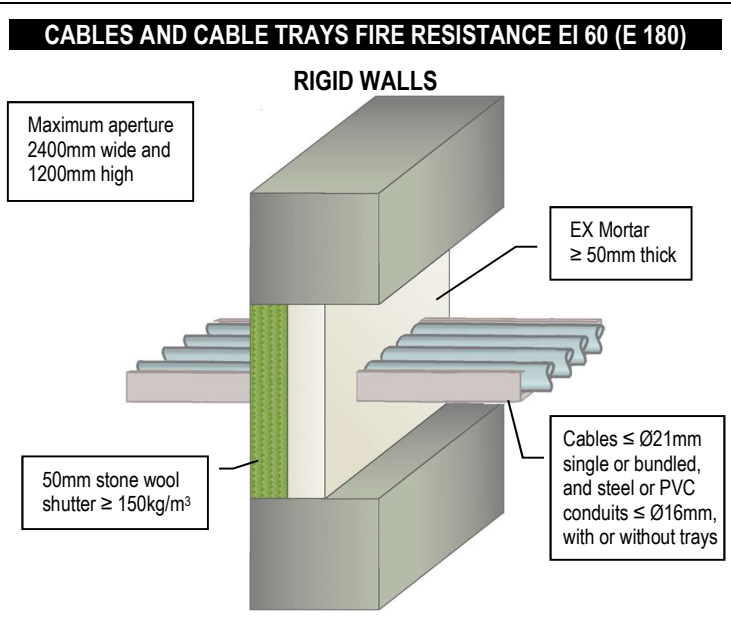
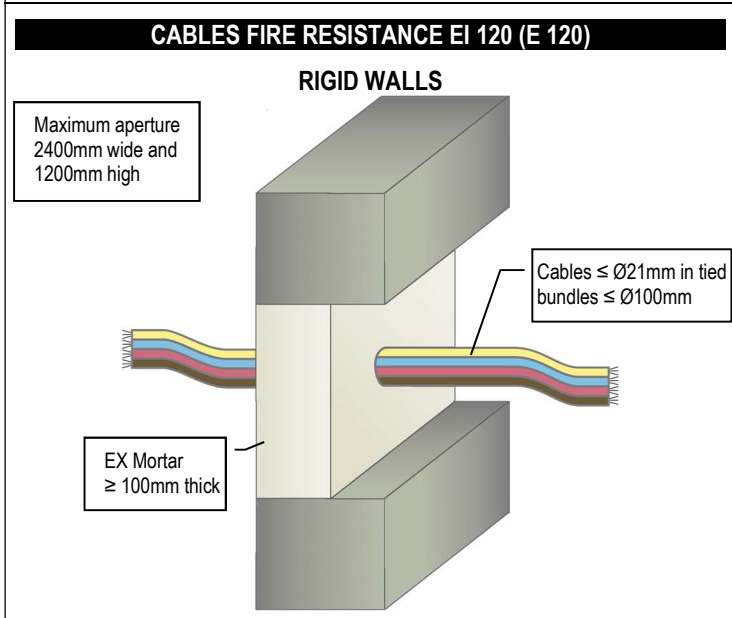
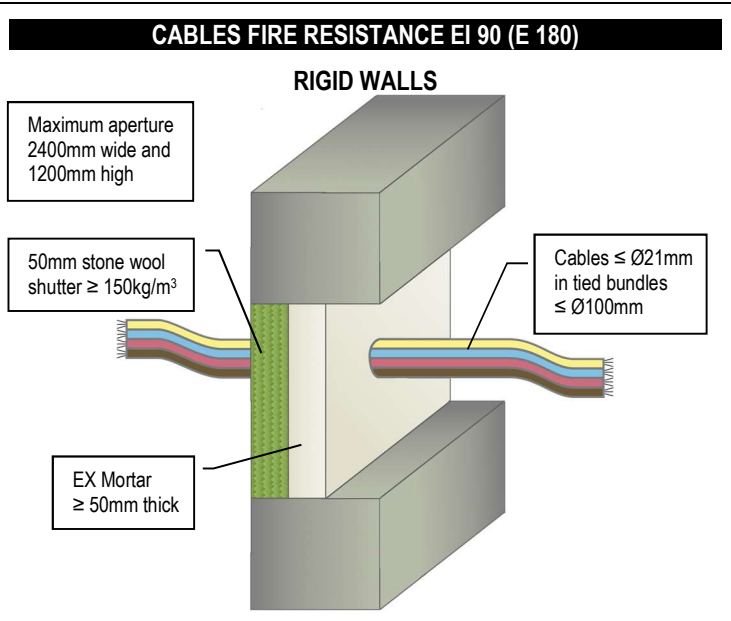
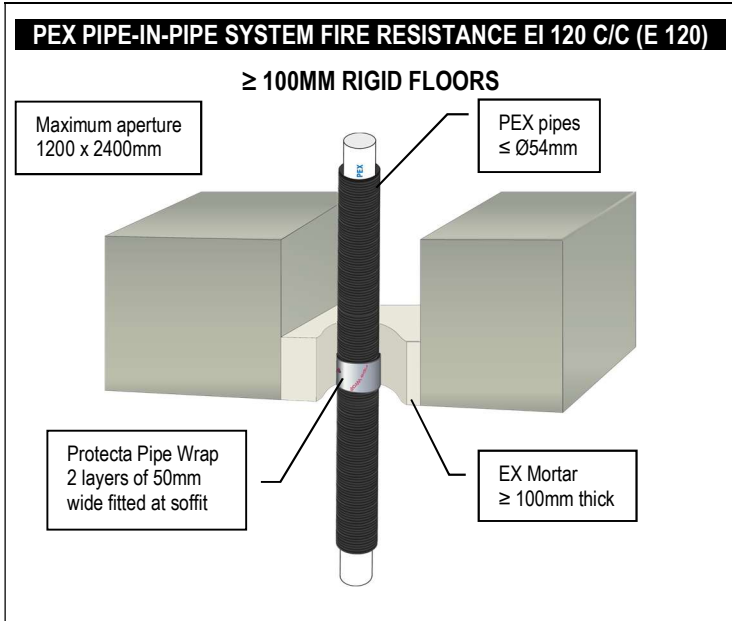

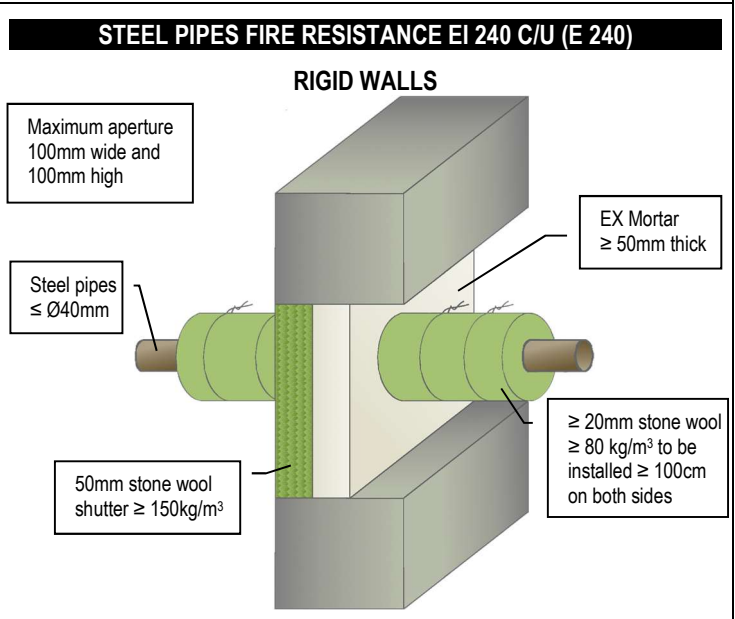
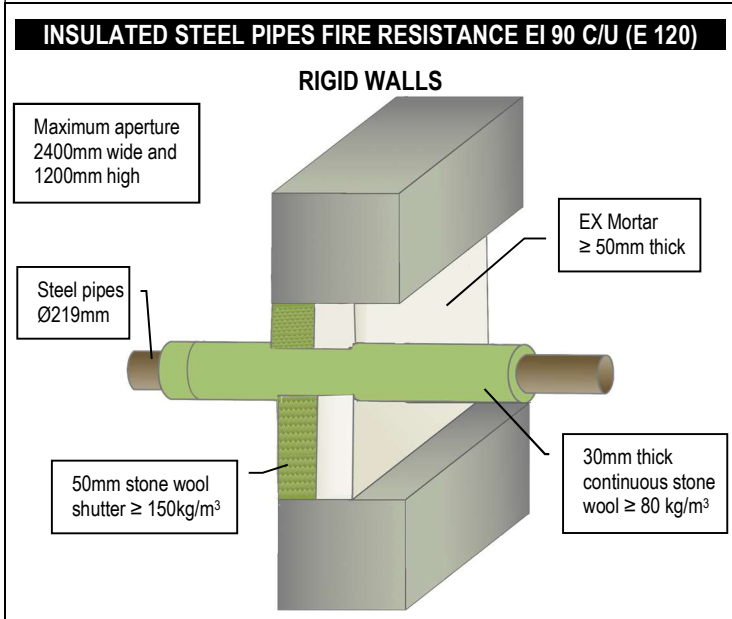
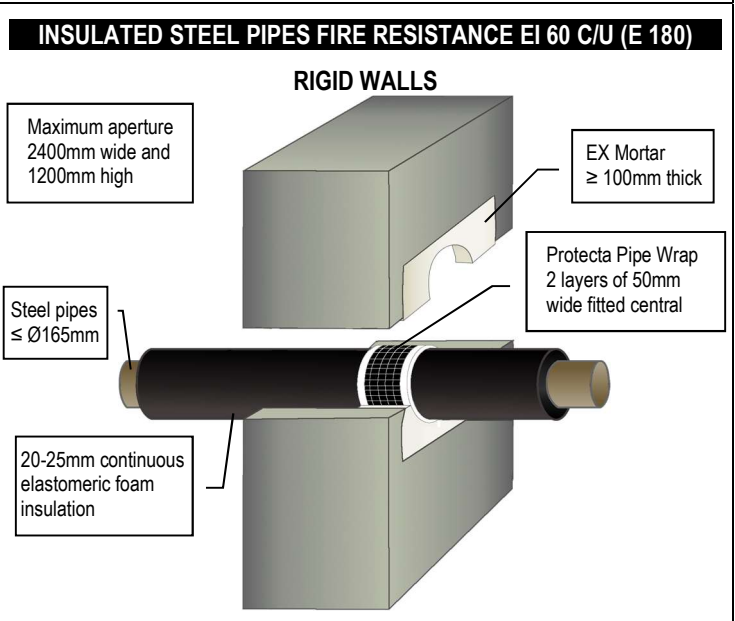
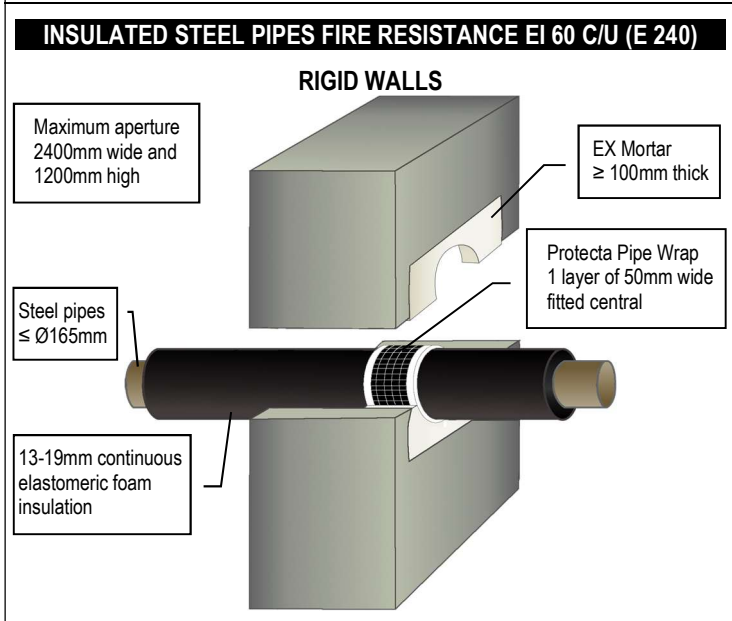
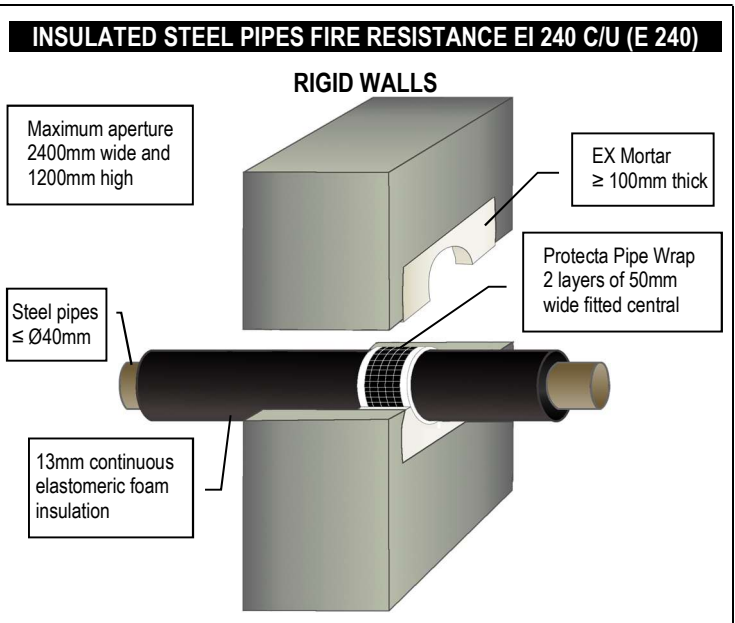
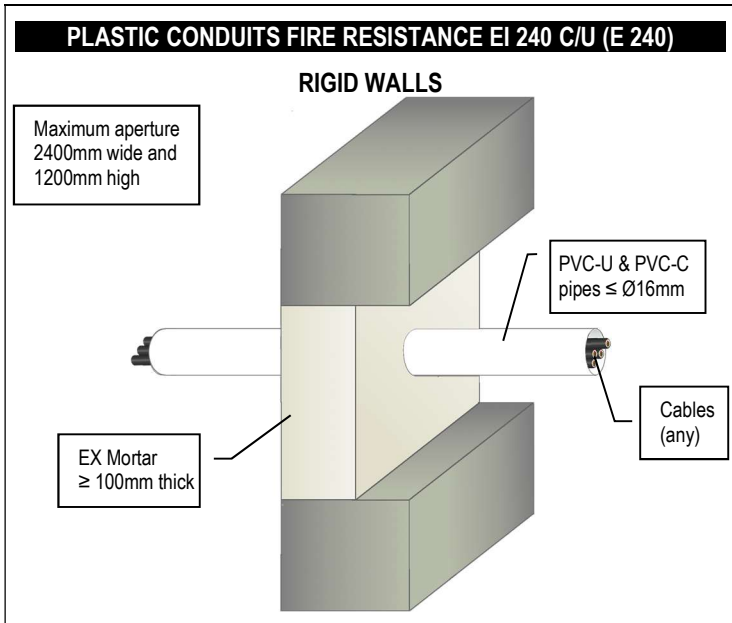

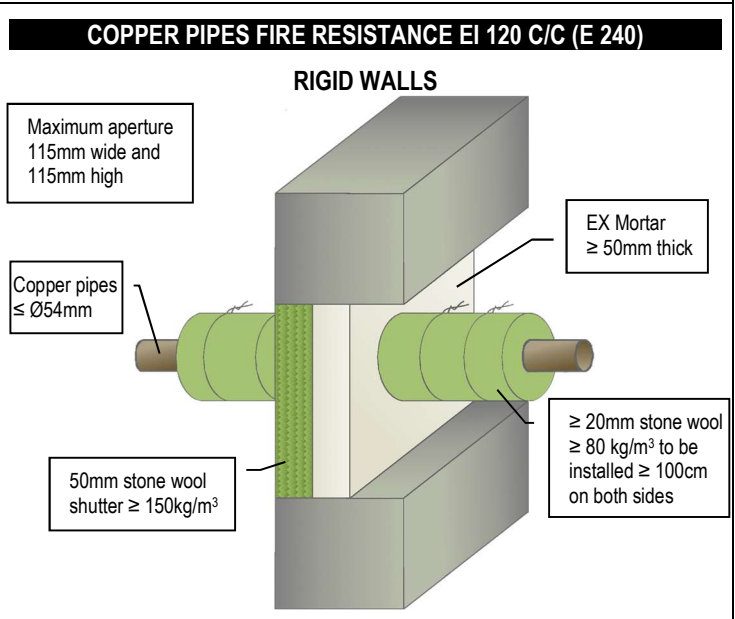
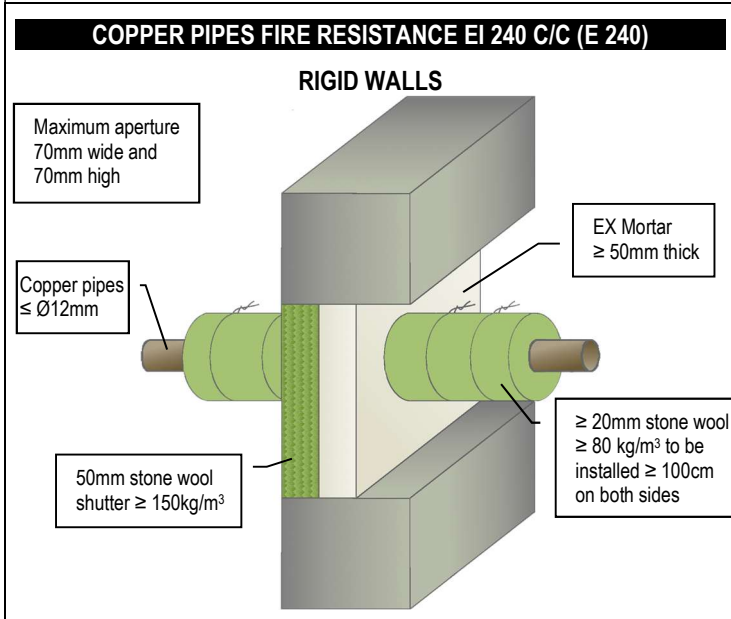
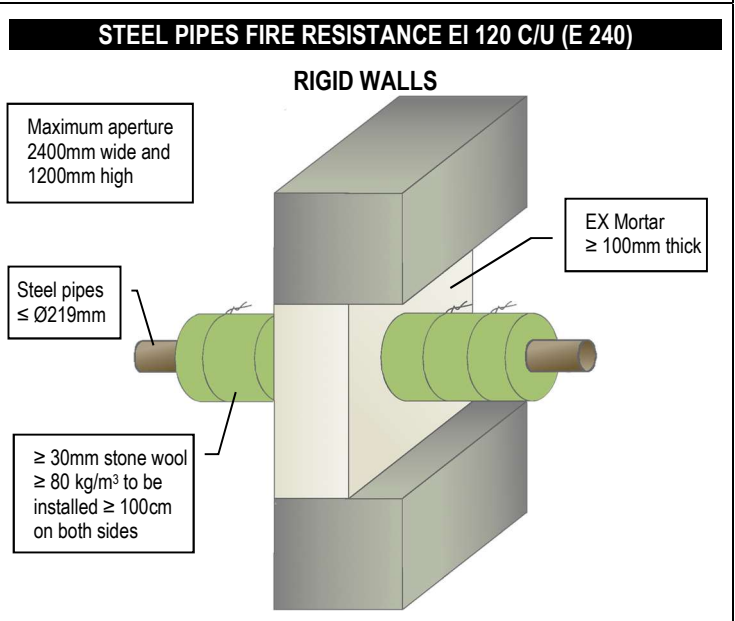
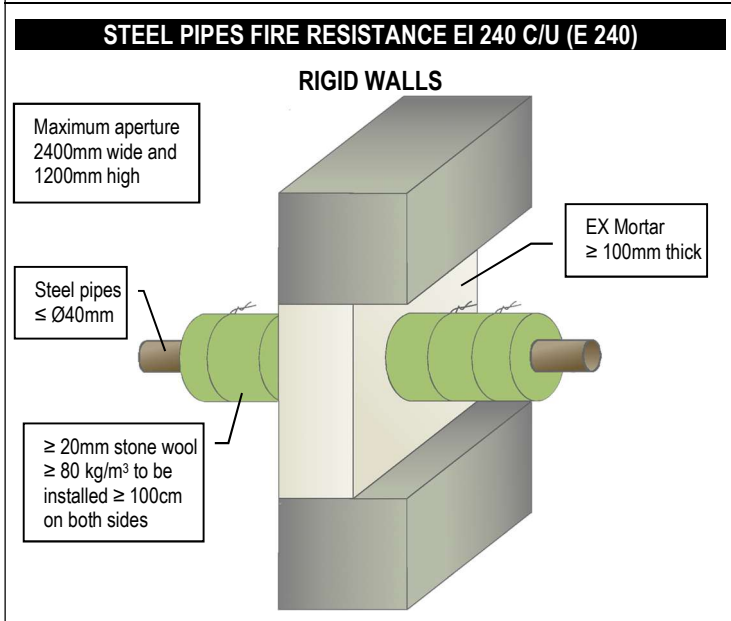
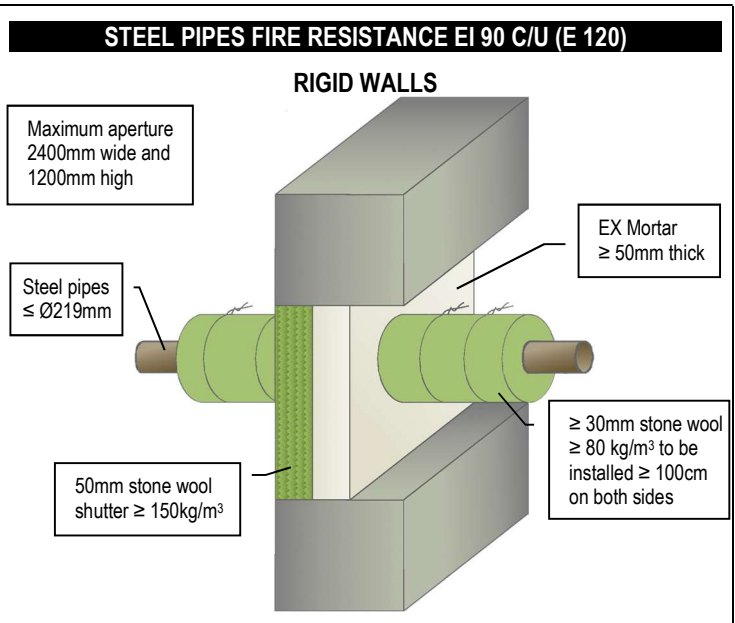
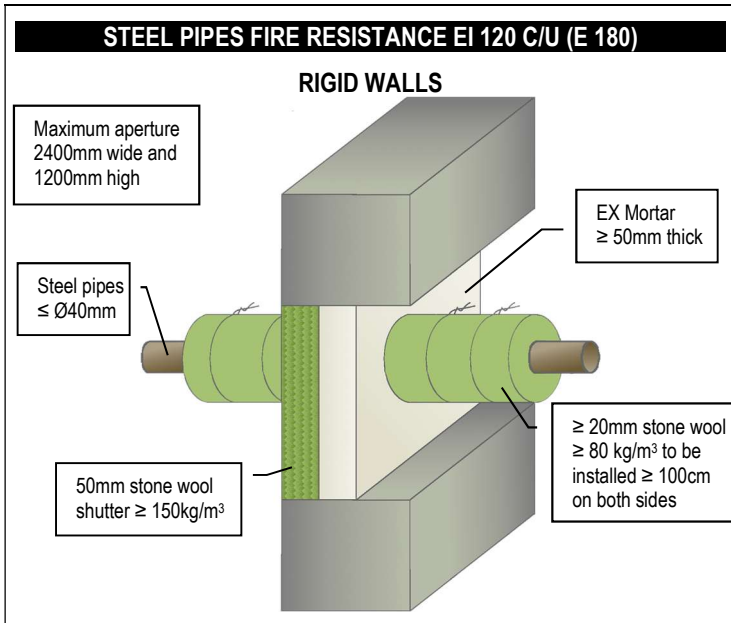

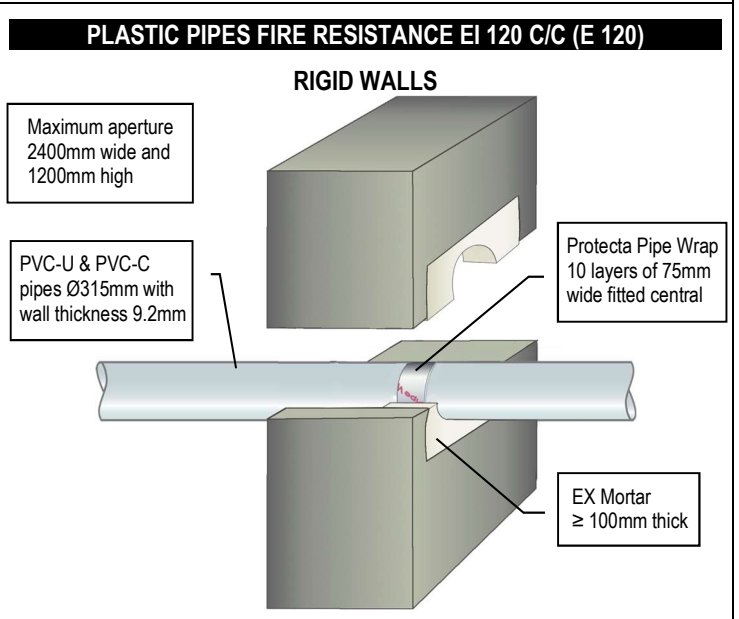
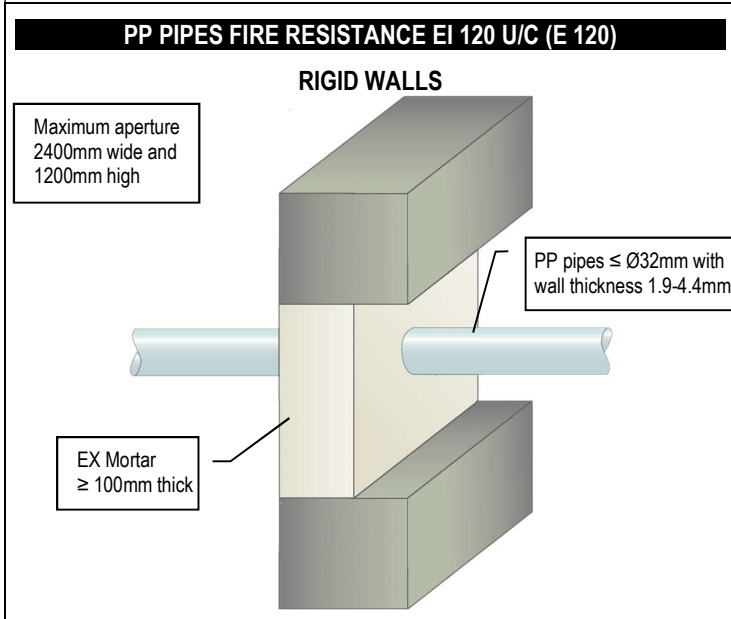
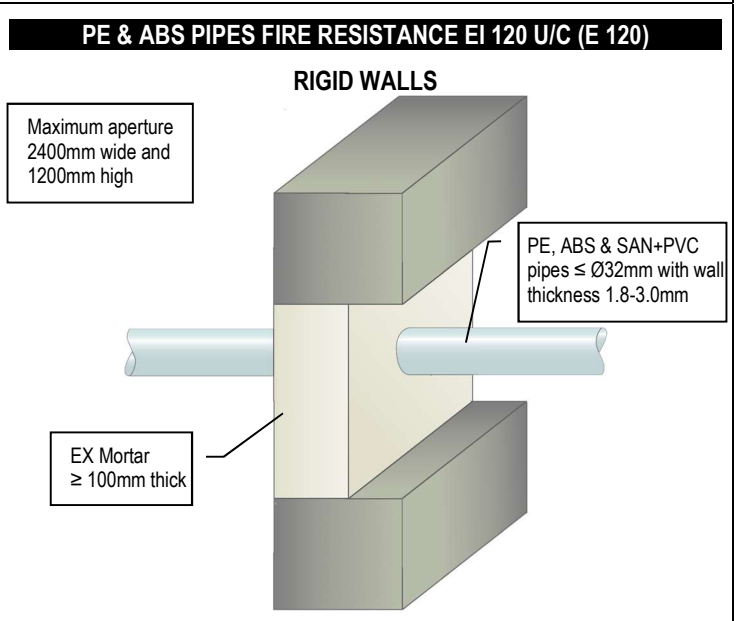
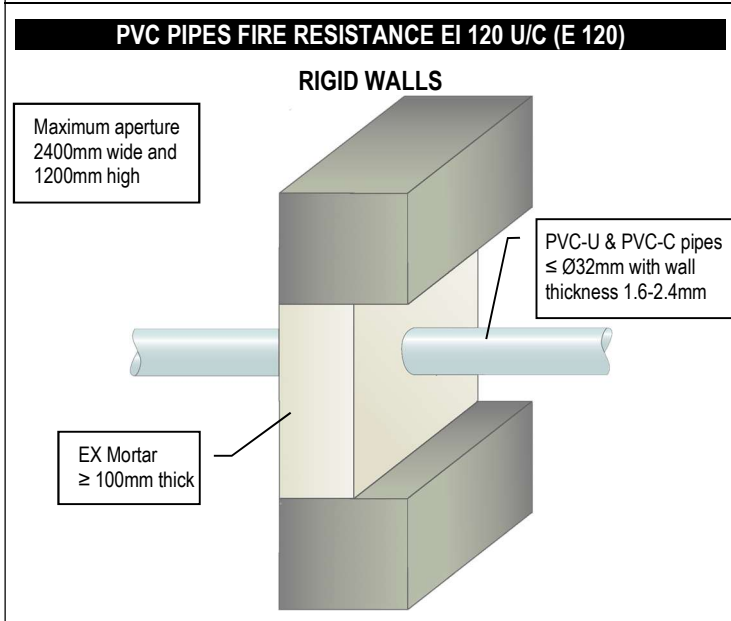
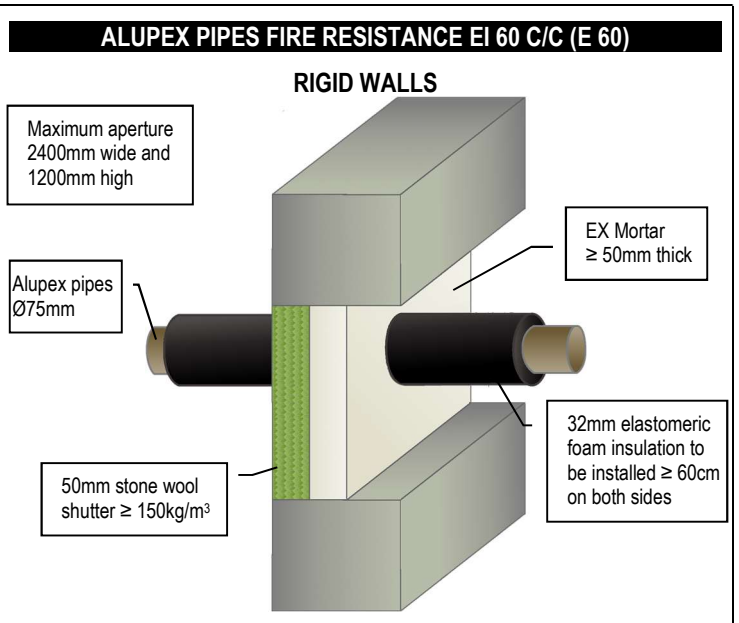
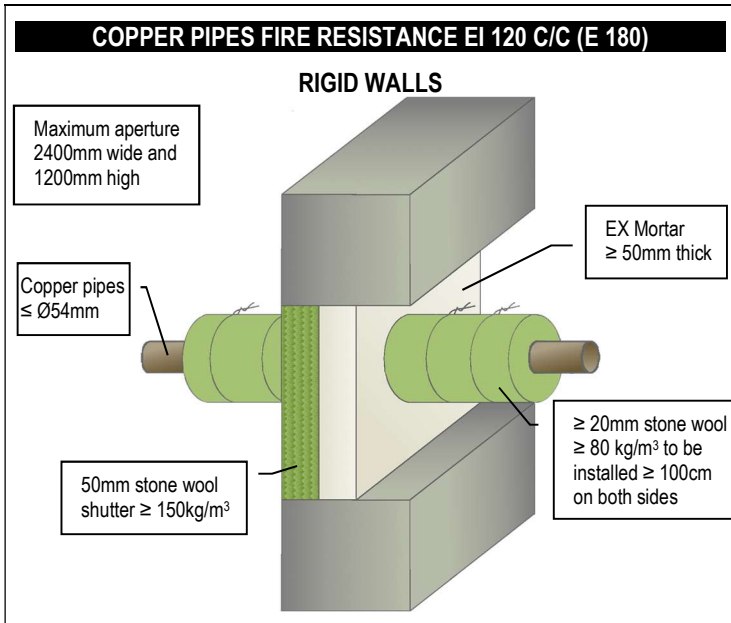

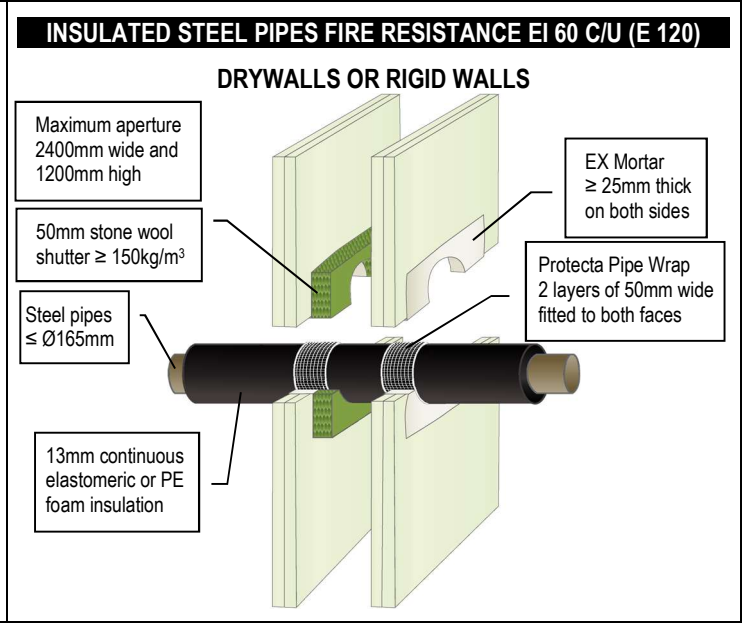
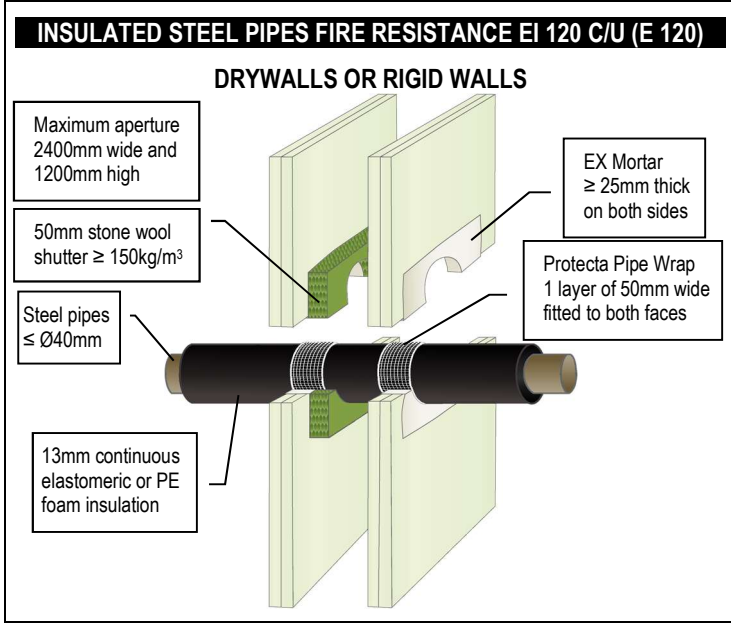
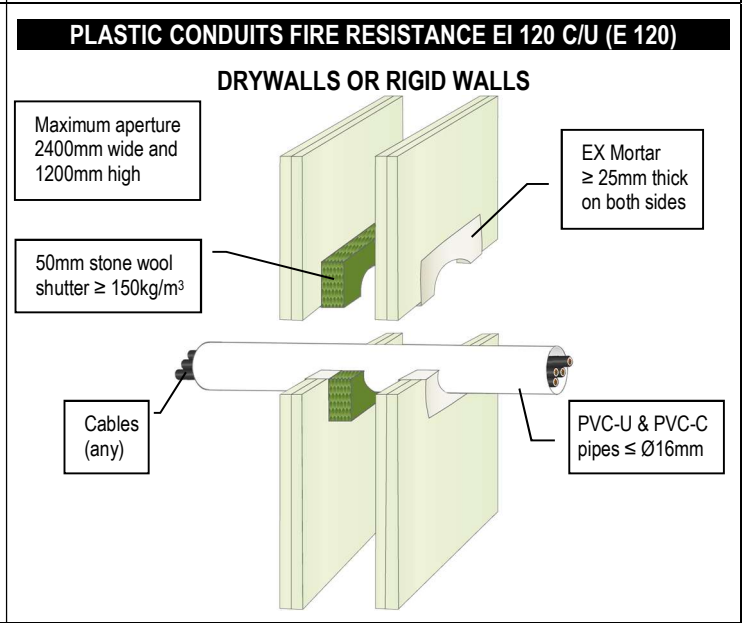
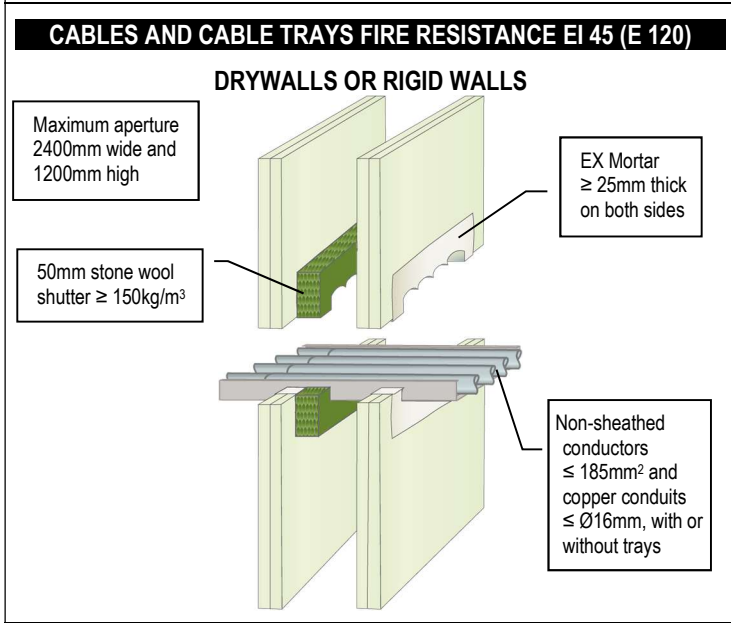
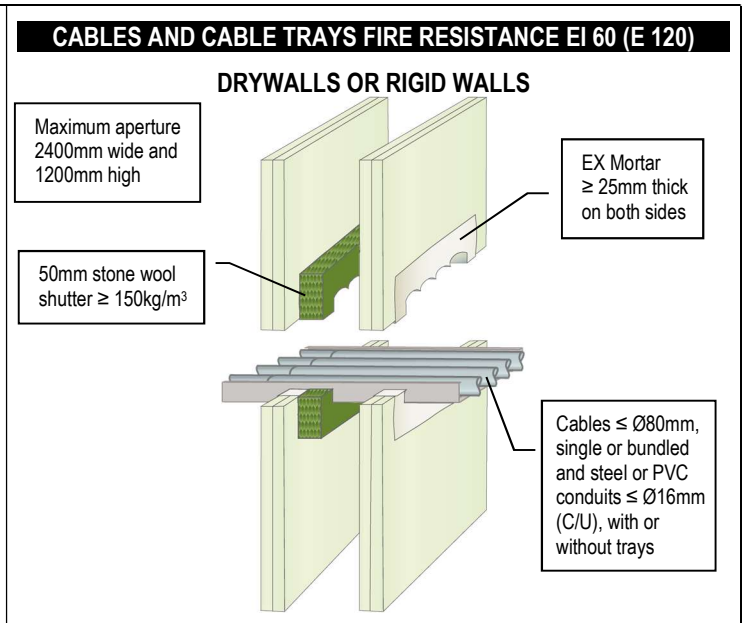
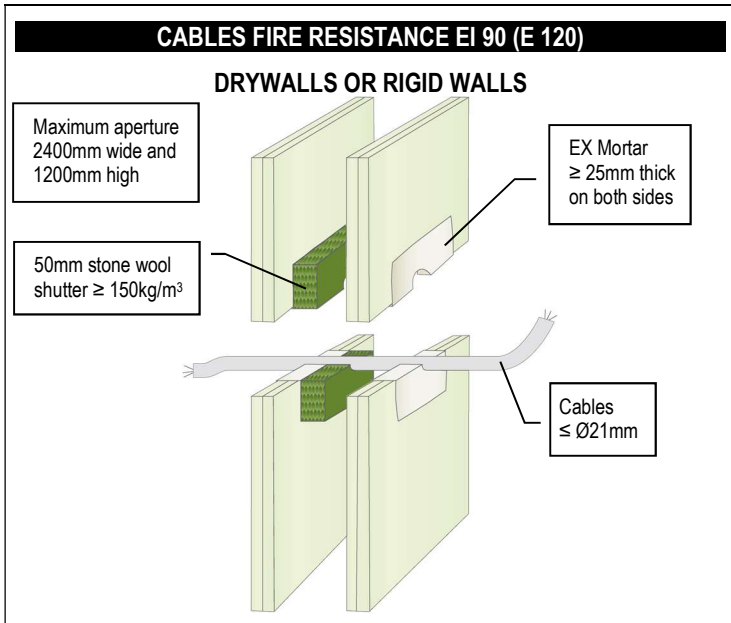

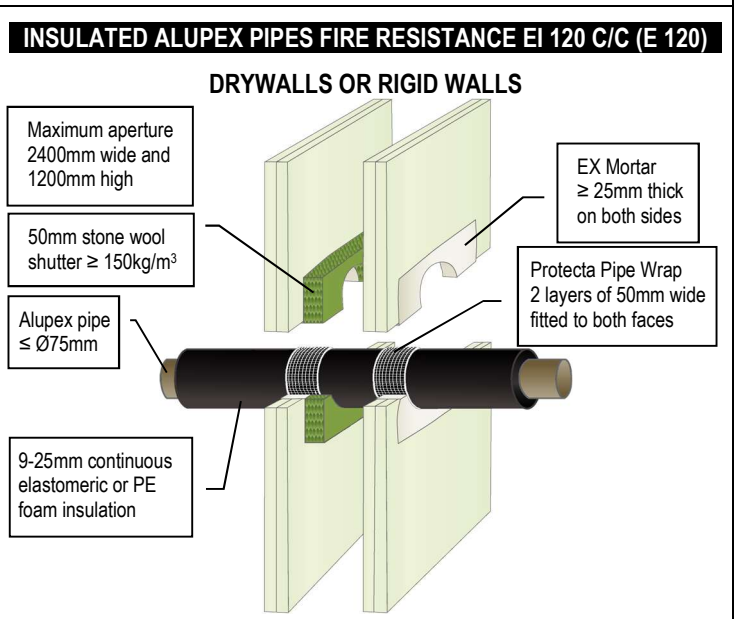
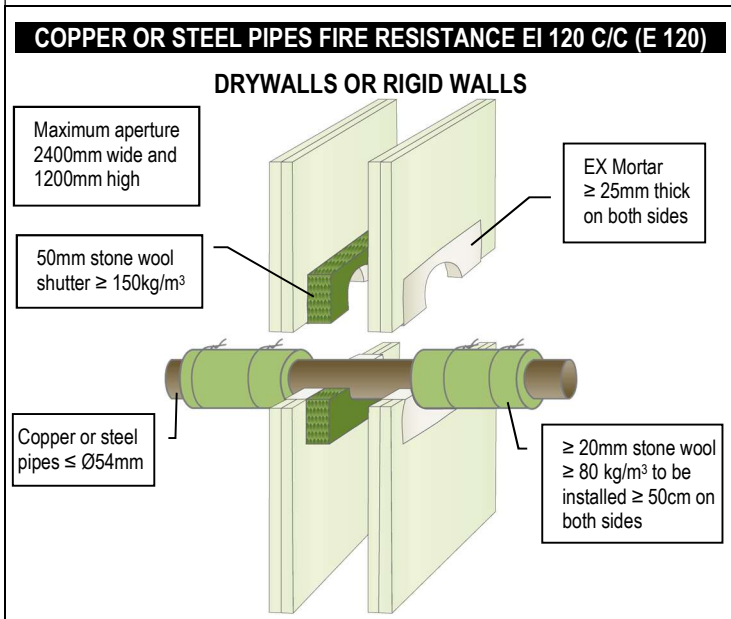
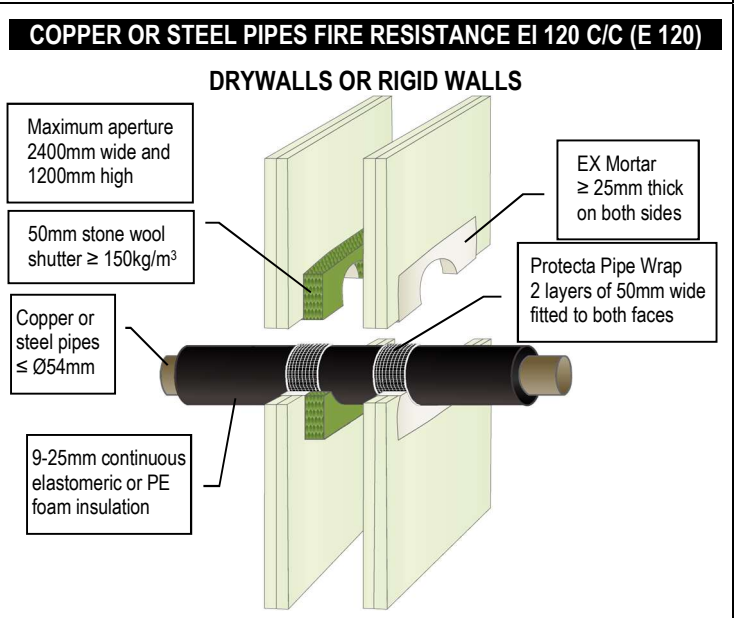
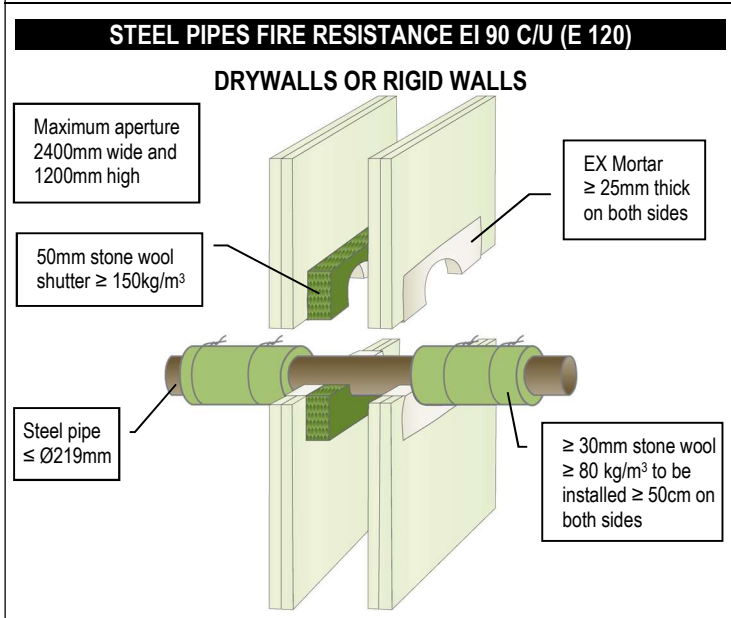
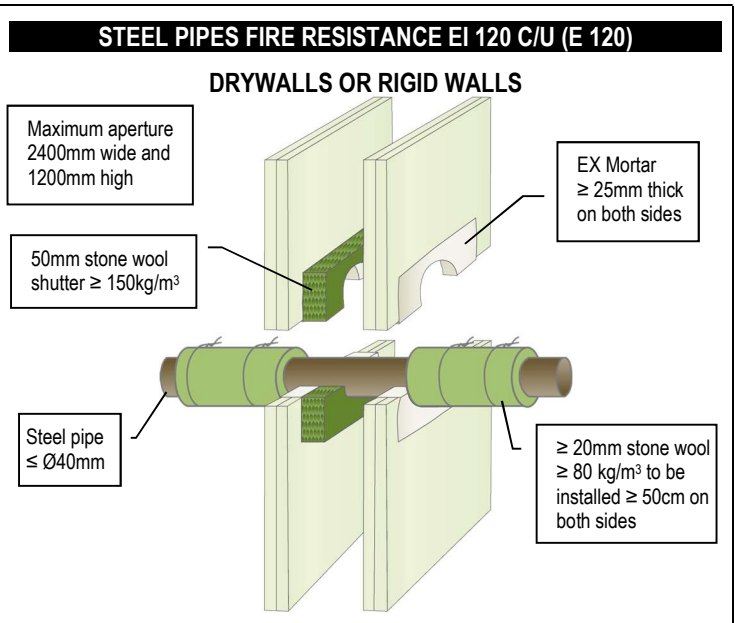
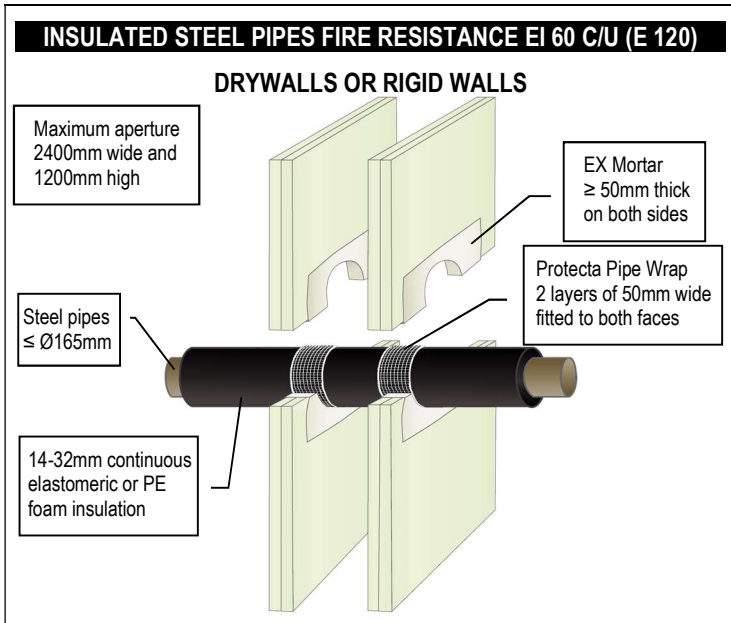

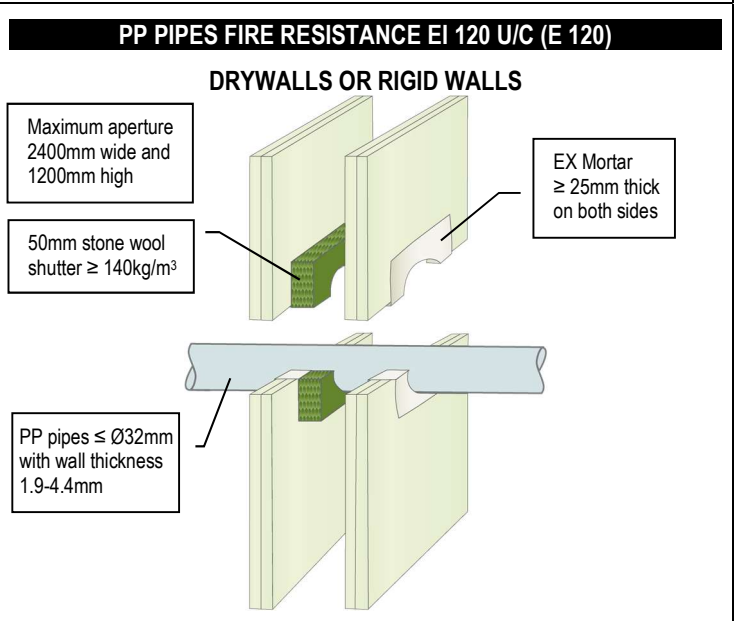
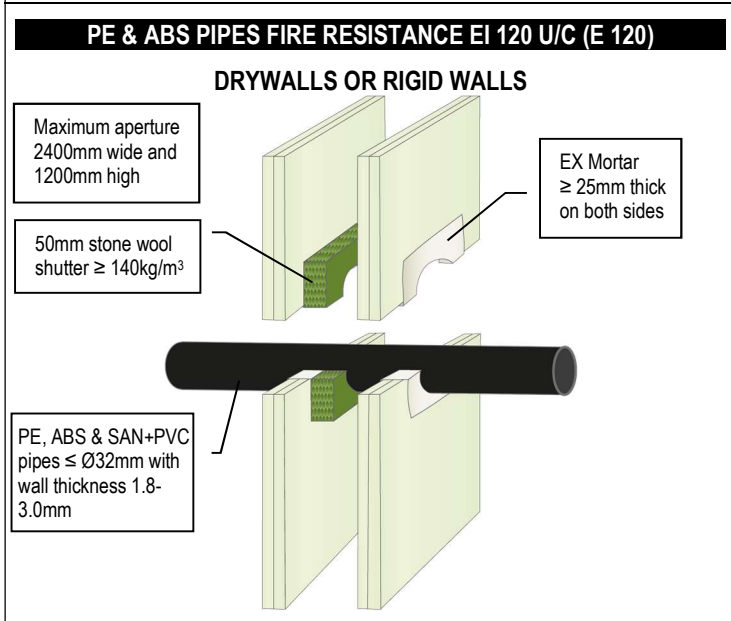
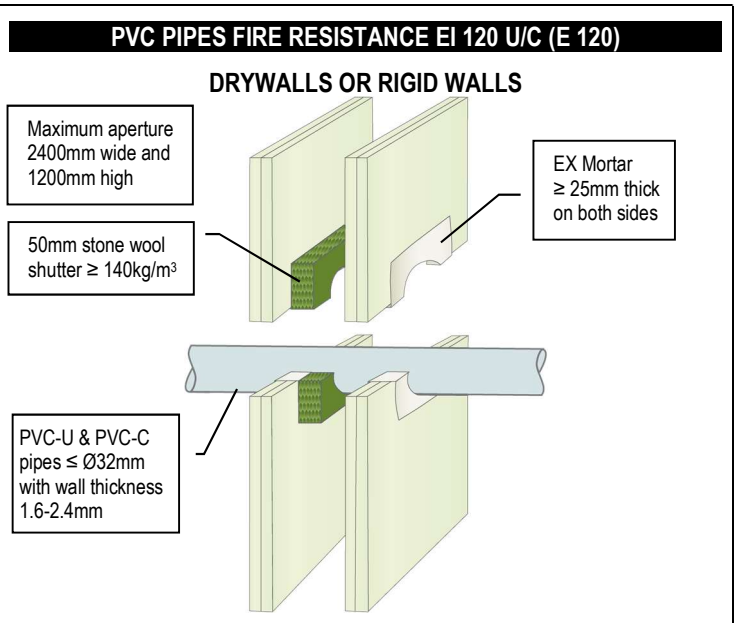
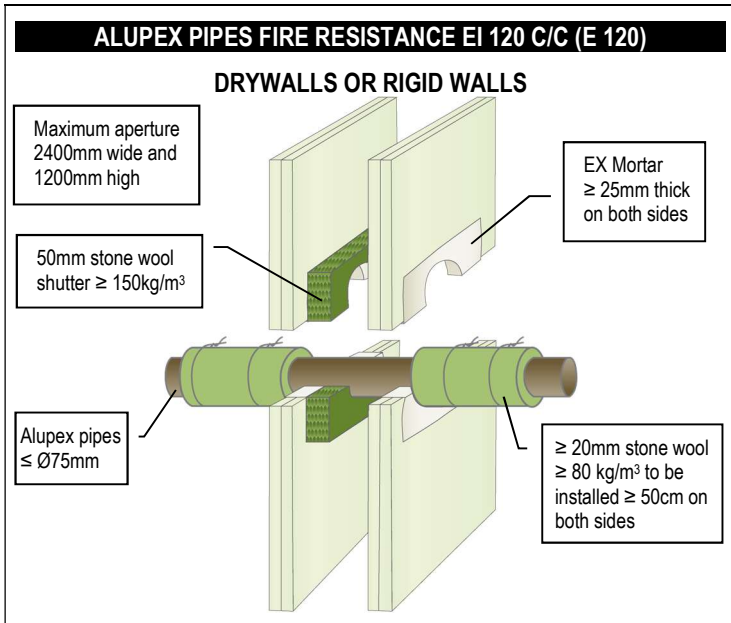

**PLASTIC PIPES FIRE RESISTANCE EI 60-120**

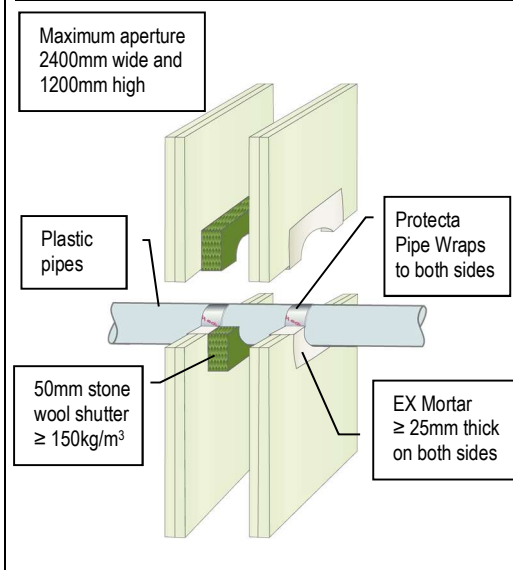

Services	Pipe Wall Thickness	Pipe Wrap	Classification
$\leq \text{Ø}40\text{mm}$ PVC-U & PVC-C	3.0 – 4.3mm	50 x 1.8mm (1 layer)	EI 60 U/C (E 120 U/C)
$\leq \text{Ø}40\text{mm}$ PE, ABS & SAN+PVC	3.2 – 3.7mm	50 x 1.8mm (1 layer)	EI 120 U/C (E 120 U/C)
$\leq \text{Ø}40\text{mm}$ PP	4.0 – 5.5mm	50 x 1.8mm (1 layer)	EI 120 U/C (E 120 U/C)
$\leq \text{Ø}110\text{mm}$ PVC-U & PVC-C	2.7 – 6.6mm	50 x 3.6mm (2 layers)	EI 90 U/C (E 120 U/C)
$\leq \text{Ø}110\text{mm}$ PE, ABS & SAN+PVC	4.2 – 10.0mm	50 x 3.6mm (2 layers)	EI 60 U/C (E 60 U/C)
$\leq \text{Ø}110\text{mm}$ PP	6.6mm	50 x 3.6mm (2 layers)	EI 90 U/C (E 120 U/C)
$\leq \text{Ø}125\text{mm}$ PVC-U & PVC-C	3.7 – 7.4mm	50 x 5.4mm (3 layers)	EI 120 U/C (E 120 U/C)
$\leq \text{Ø}125\text{mm}$ PE, ABS & SAN+PVC	12.0mm	50 x 5.4mm (3 layers)	EI 120 U/C (E 120 U/C)
$\leq \text{Ø}125\text{mm}$ PP	17.1mm	50 x 5.4mm (3 layers)	EI 90 U/C (E 120 U/C)
$\leq \text{Ø}160\text{mm}$ PVC-U & PVC-C	3.2 – 9.5mm	50 x 7.2mm (4 layers)	EI 60 U/C (E 60 U/C)
$\leq \text{Ø}160\text{mm}$ PE, ABS & SAN+PVC	12.0mm	50 x 7.2mm (4 layers)	EI 90 U/C (E 120 U/C)
$\leq \text{Ø}160\text{mm}$ PP	4.0 – 21.9mm	50 x 7.2mm (4 layers)	EI 60 U/C (E 120 U/C)